

Instruction Manual

REGULUS SRS 3 Controller

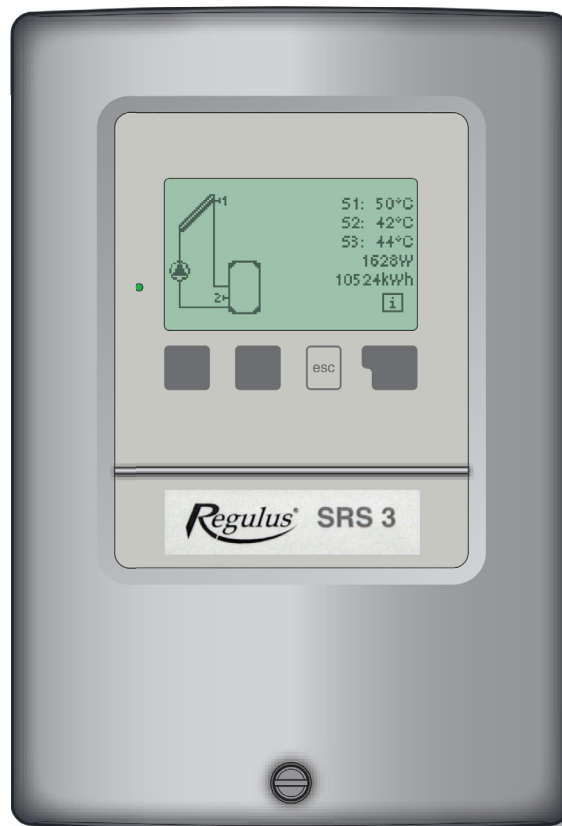

CE

EN
v 1.2

Regulus[®]

CONTENTS

Part A - Description and Installation

A 1 - Specification	3
A 2 - About the controller	4
A 3 - Scope of supply	4
A 4 - Explanation of symbols	4
A 5 - Hydraulic variants	5
A 6 - Wall installation	6
A 7 - Electrical wiring	7
A 8 - Installing the temperature sensors	7

Part B - Electric Wiring

B 1 - Solar system with storage tank	8
B 2 - Solar system with thermostat for storage tank heating or cooling	8
B 3 - Solar system with by-pass	9
B 4 - Solar system with return line preheating	9
B 5 - Solar system with thermally stratified storage tank	10
B 6 - Solar system with heat exchanger	10
B 7 - Solar system with 2 collector fields (East/West)	11
B 8 - Solar system with 2 pumps	11
B 9 - Solar system with 2 storage tanks and zone valve	12
B10 - Solar system with 2 storage tanks / pumps	12
B11 - Solar system with 2 storage tanks and heat exchange pump	13
B12 - Solar system with pool	13
B13 - Solar system with pool and storage tank	14
B14 - Solar system + cooling 1	14
B15 - Solar system + cooling 2	15
B16 - Solar system + cooling 3	15
B17 - Solar system + solid fuel boiler	16
B18 - Solar system + zone valve + thermostat	16
B19 - One temperature difference controller $1 \times \Delta T$ and one thermostat	17
B20 - Two temperature difference controllers $2 \times \Delta T$	17

Part C - Controller Use

C 1 - Display and input	18
C 2 - Menu structure	19
C 3 - Turning on for the first time	20
C 4 - Free commissioning	20

Part D - Parameter Settings

D 1 - Measurement values	21
D 2 - Statistics	22
D 3 - Display mode	23
D 4 - Operating mode	24
D 5 - Settings	25
D 6 - Protective functions	31
D 7 - Special functions	34
D 8 - Menu lock	38
D 9 - Service values	39
D10 - Language	40

Part E - Defects and Maintenance

E 1 - Error and info messages	41
E 2 - Replacing the fuse	42
E 3 - Maintenance	42
E 4 - Useful hints and tricks	43
E 5 - Disposal	44

General instructions

These installation and operating instructions contain basic instructions and important information regarding safety, installation, commissioning, maintenance and the optimal use of the unit.

Therefore these instructions must be read completely and understood by the installation technician/specialist and by the system user before installing, commissioning and operating the unit.

The installation shall be done in compliance with valid standards and rules. The controller does not under any circumstances replace any safety devices (e.g. safety valve, air vent valve etc.) to be installed into a solar circuit!

Installation of the unit may only be carried out by specialists who possess the appropriate training.

For the user:

Make sure that the specialist gives you detailed information on the function and operation of the controller.

Always keep these instructions in the vicinity of the controller.

A - DESCRIPTION AND INSTALLATION

A 1 - Specification

Electric specification:

Mains voltage	230 V ~ ±10 %
Mains frequency	50-60 Hz
Power consumption	2 VA
Switched power	
Electronic relay R1	min. 20 W, max. 120 W for AC3
Mechanical relay R2	max. 460 VA for AC1 / 185 W for AC3 (AC1 - resistive load, AC3 - inductive load)
Internal fuse	2A slow-blow, 250 V
El. protection	IP40
Protection class	II
Sensor inputs	3× Pt1000
Measuring range	-40 °C to 300 °C

Permissible ambient conditions:

Ambient temperature

for controller operation	0-40 °C
for transport/storage	0-60 °C

Air humidity

for controller operation	max. 85 % rel. humidity at 25 °C
for transport/storage	no moisture condensation permitted

Other specifications and dimensions:

Housing design	2-part, ABS plastic
Installation methods	wall installation, optionally panel installation
Overall dimensions	163 × 110 × 52 mm
Aperture installation dimensions	157 × 106 × 31 mm
Display	fully graphical display, 128 × 64 dots
Light diode	multicolour
Operation	4 entry keys

Optional temperature sensors:

Immersion sensor	Pt1000, with lead TT/S2 up to 180 °C
Immersion sensor	Pt1000, with lead TT/P4 up to 95 °C
Pipe-mounted sensor	Pt1000, pipe-mounted sensor TR/P4 up to 95 °C
Sensor leads	min. 2× 0,75 mm ² , extendable up to 30m max.

Temperature resistance table for Pt1000 sensors:

°C	0	10	20	30	40	50	60	70	80	90	100
Ω	1000	1039	1077	1116	1155	1194	1232	1270	1308	1347	1385

A 2 - About the controller

The REGULUS SRS 3 controller is designed to control solar systems with 1 solar collector field and up to 2 loads or 1 load and up to 2 solar collector fields.

It can be used in solar systems for DHW and pool heating or backup heating.

It facilitates efficient use and function control of solar systems, enables speed control of a solar pump and protective functions for collectors and tank. The device has simple operation, help texts for individual functions and menu in several languages.

It enables easy display and selection from 18 typical solar connection schemes or just a simple function of one differential thermostat and a standard thermostat or 2 differential thermostats.

- both graphics and texts on a backlit display
- simple viewing of the current measurement values
- analysis and monitoring of the system also by means of statistical graphics
- extensive setting menus with explanations
- menu lock can be activated to prevent unintentional setting changes
- usual preset parameters in factory setting
- further measurement and switching applications using a temperature difference and a thermostat function

A 3 - Scope of supply

- SRS 3 Controller
- 3 screws 3.5 × 35 mm and 3 plugs 6 mm for wall installation
- 6 strain relief clips with 12 screws
- Replacement fuse 2A slow-blow, 250 V
- Installation, wiring and operating instructions
- 3 Pt1000 temperature sensors for immersion sleeves, up to 180 °C

A 4 - Explanation of symbols



Danger

Failure to observe these instructions can result in danger to life from electric voltage.



Danger

Failure to observe these instructions can result in serious damage to health such as scalding, or even life-threatening injuries.



Danger

Failure to observe these instructions can result in destruction of the unit or the system, or damage to the environment.



Caution

Information especially important for the function and optimal use of the unit and the system.

A 5 - Hydraulic variants

1. Solar system with a storage tank
2. Solar system with a thermostat for storage tank heating or cooling
3. Solar system with a bypass
4. Solar system with a heating return pre-heating
5. Solar system with a thermally stratified storage tank
6. Solar system with a heat exchanger
7. Solar system with 2 collector fields (East/West)
8. Solární systém se 2 kolektorovými poli a 2 čerpadly
9. Solar system with 2 storage tanks and a zone valve
10. Solar system with 2 storage tanks and 2 pumps
11. Solar system with two storage tanks and a heat exchange pump
12. Solar system with a pool
13. Solar system with a pool and storage tank
14. Solar system + cooling 1
15. Solar system + cooling 2
16. Solar system + cooling 3
17. Solar system + solid-fuel boiler
18. Solar system + zone valve + thermostat
19. One differential ΔT controller and 1 thermostat (no solar functions)
20. 2 temperature difference controllers $2 \times \Delta T$ (no solar functions)

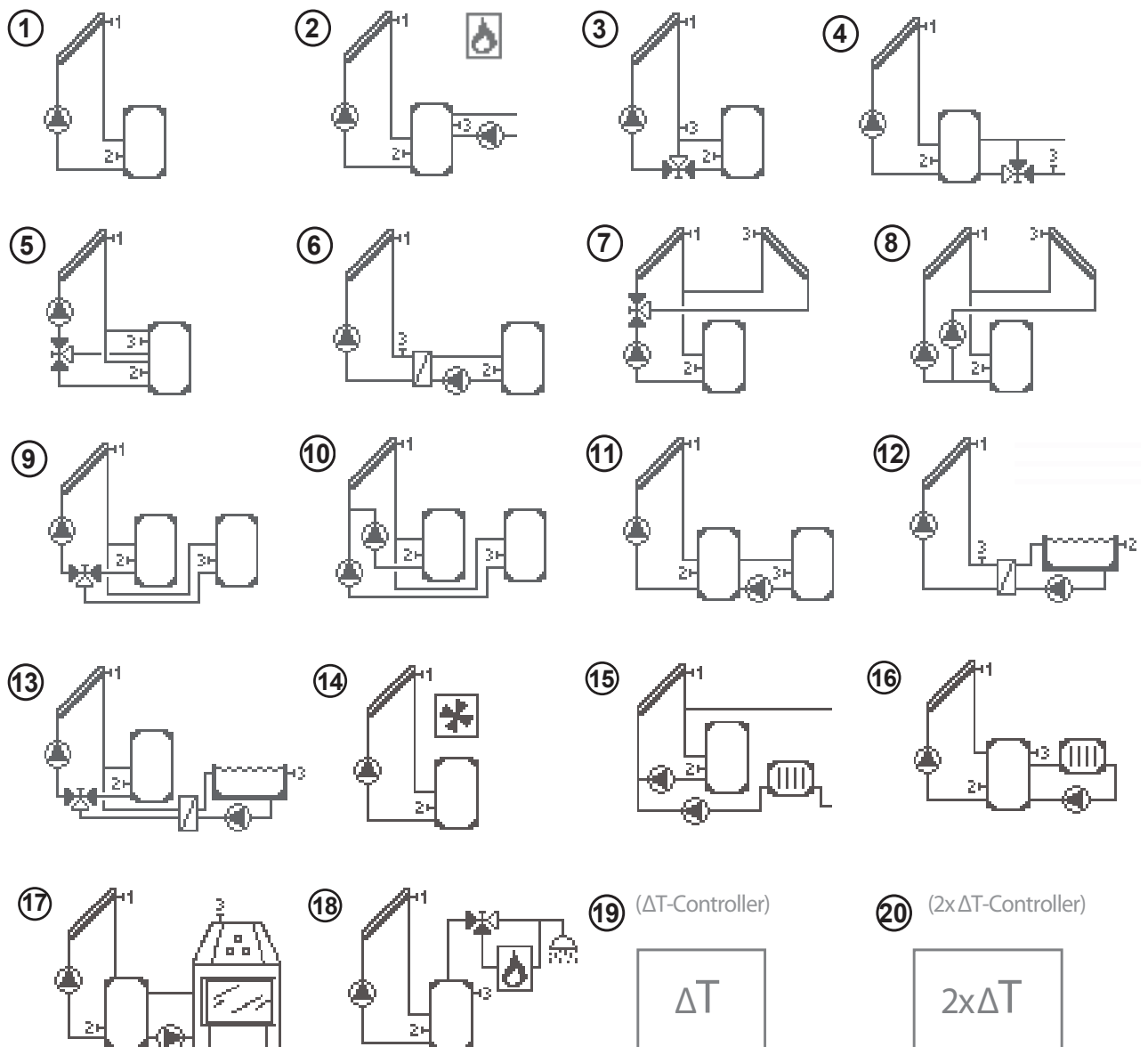

A 6 - Wall installation

Install the controller only in dry areas and under the ambient conditions described in Chapter A 1.

Installation instructions:

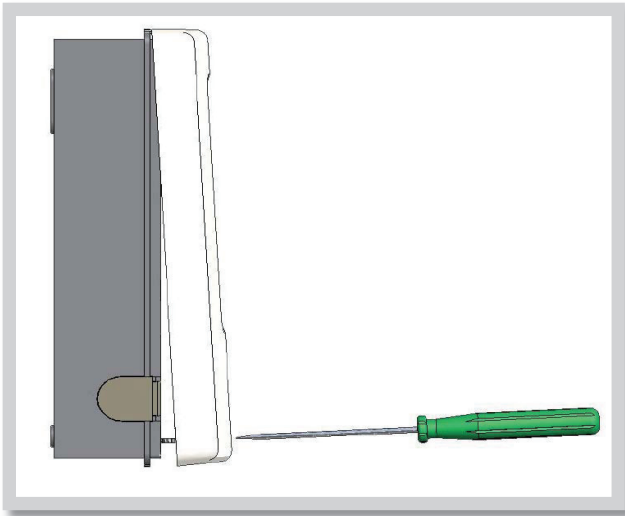

Fig. A 3.1.1

1. Unscrew cover screw completely.
2. Carefully pull upper part of housing from lower part.
3. Set upper part of housing aside, being sure not to touch the electronics when doing so.
4. Hold the lower part of the housing up to the selected position and mark the 3 mounting holes. Make sure that the wall surface is as even as possible so that the housing does not become distorted when it is screwed on.

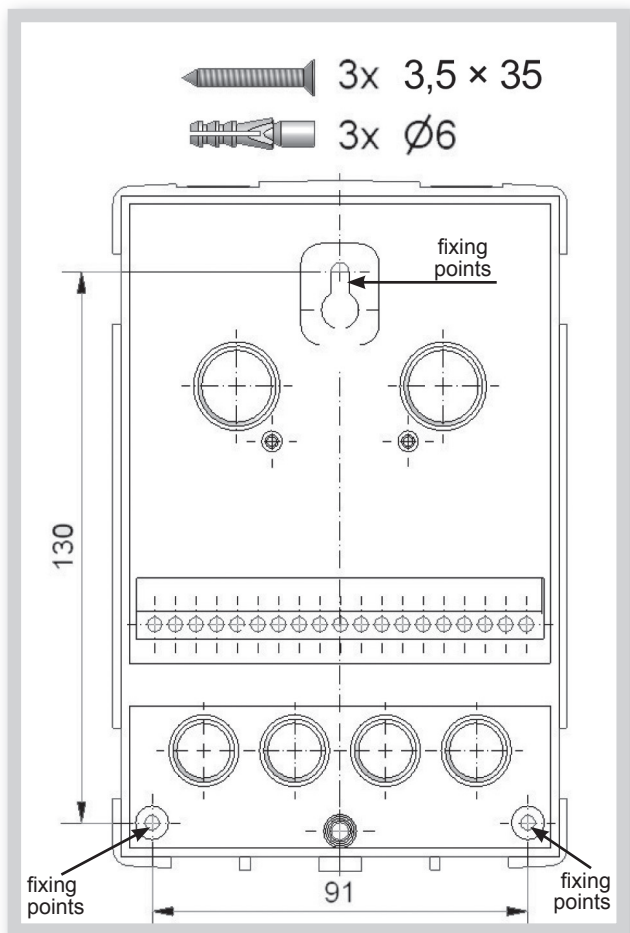

Fig. A 3.1.2

5. Using a drill and size 6 bit, drill 3 holes at the points marked on the wall and push in the plugs.
6. Insert the upper screw and screw it in slightly.
7. Fit the upper part of the housing and insert the other two screws.
8. Align the housing and tighten the three screws.

A 7 - Electrical wiring



Low-voltage cables such as temperature sensor cables must be routed separately from mains voltage cables. Feed temperature sensor cables only into the left-hand side of the unit, and mains voltage cables only into the right-hand side.



The controller is not equipped with a mains switch. For this purpose please use e.g. a circuit breaker or just unplug the device. The cables being connected to the unit must not be stripped by more than 55 mm, and the cable jacket must reach into the housing just to the other side of the strain relief.



Relay R1 is only suitable for standard pumps (20-120VA) which are speed-controlled via the controller. The internal wiring of the controller is such that residual currents flow over relay R1 even in the rest condition. Therefore under no circumstances may valves, contactors or other consumers with low power consumption be operated on this output.



With hydraulic variant 1 (Solar system with storage tank) relays R1 and R2 are switched on simultaneously.

Wiring instructions:

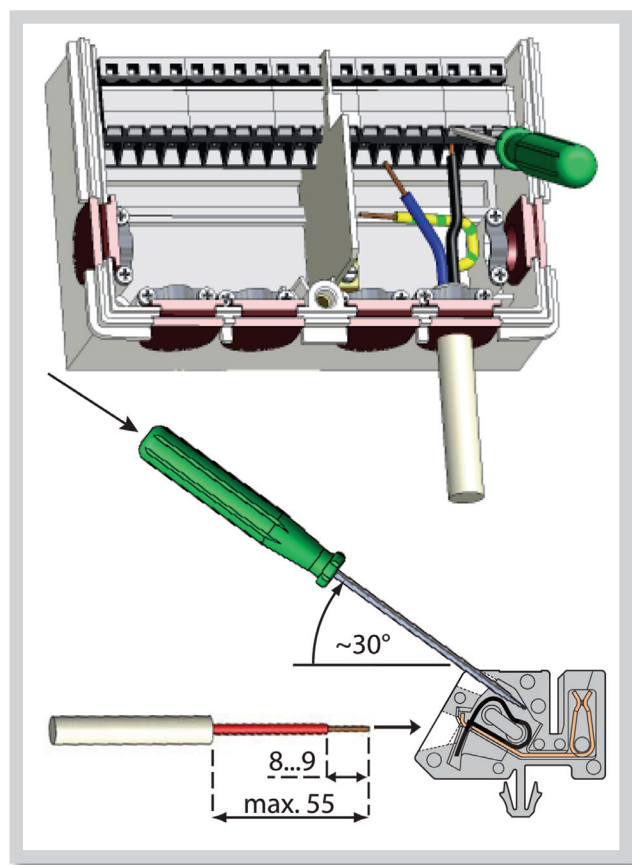

Fig. A 4.1

1. Make sure the circuit breaker is in off position and power supply is off.
2. Select a suitable hydraulic scheme (Chapters B1 to B20)
3. Open the controller.
4. Strip the cable by 55 mm max., insert and fit the cable strain relief. Strip the last 8-9 mm of all the wires (Fig. A 4.1).
5. Open the terminals using a flat screwdriver (Fig. A 4.1) and wire the leads following the diagrams (Chapter B1 to B20).
6. Refit the upper housing part and fasten with screw.
7. Switch on mains voltage and place controller in operation.

A 8 - Installing the temperature sensors



The controller operates with Pt1000 temperature sensors.

Max. sensor lead length is 30 m and its cross section at least 0.75 mm².

Make sure that the terminals of extension cables and sensors are properly tightened. Use only immersion or pipe-mounted sensors. For solar collectors, use sensors of a suitable temperature resistance (min. 180 °C) that are enclosed in the supply. The temperature sensor cables must be routed separately from mains voltage cables!

B - ELECTRIC WIRING

B 1 - Solar system with storage tank

Example: solar system with storage tank and el. heating rod with integrated thermostat.

Sensor connection - max. 12V

Mains voltage - 230V 50Hz

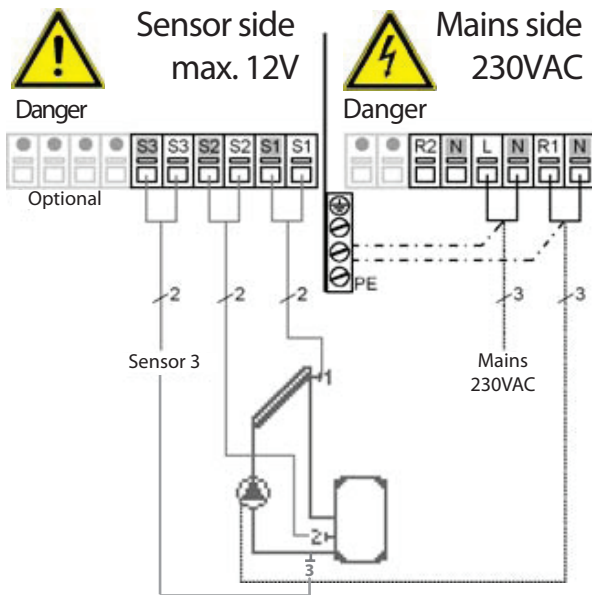

Low voltage - sensor connection

Terminal: connection for:

- S1 (2×) sensor 1 collector
 - S2 (2×) sensor 2 storage tank
 - S3 (2×) sensor 3 (e.g. for heat balance)
- The polarity of the sensors is freely selectable.

Mains voltage - 230V 50Hz

Terminal: connection for:

- L mains phase conductor L
- N mains neutral conductor N
- R1 pump L (speed)
- N pump N
- R2 pump L (no speed control)
- R1 pump N
- PE protective conductor (green-yellow)

Note: Sensor 3 can be used to measure heat quantity supplied by the solar system.



Caution

R1 output: for speed control of standard pumps, minimum load 20VA.



Caution

In B1 wiring diagram of Solar system with storage tank, the relays R1 and R2 close together, i.e. when closed, voltage will appear on R2 terminal as well.

B 2 - Solar system with thermostat for storage tank heating or cooling

Example: solar system with storage tank heated with a gas boiler or el. heating rod, controller regulated.

Sensor connection - max. 12V

Mains voltage - 230V 50Hz

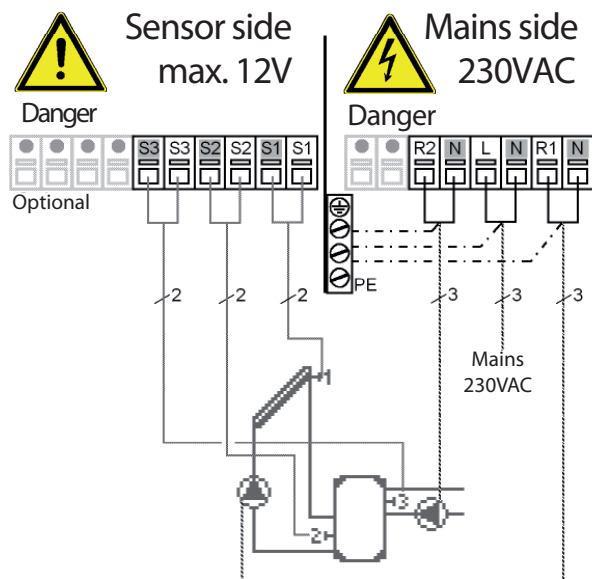

Low voltage - sensor connection

Terminal: connection for:

- S1 (2×) sensor 1 collector
 - S2 (2×) sensor 2 storage tank lower
 - S3 (2×) sensor 3 storage tank upper
- The polarity of the sensors is freely selectable.

Mains voltage - 230V 50Hz

Terminal: connection for:

- L mains phase conductor L
- N mains neutral conductor N
- R1 pump L (speed)
- N pump N
- R2 thermostat function L
- N thermostat function N
- PE protective conductor (green-yellow)



Caution

R1 output: for speed control of standard solar pumps, minimum load 20VA.

B 3 - Solar system with by-pass

Example: solar system with a long piping from pump station to storage tank.

Sensor connection - max. 12V

Mains voltage - 230V 50Hz

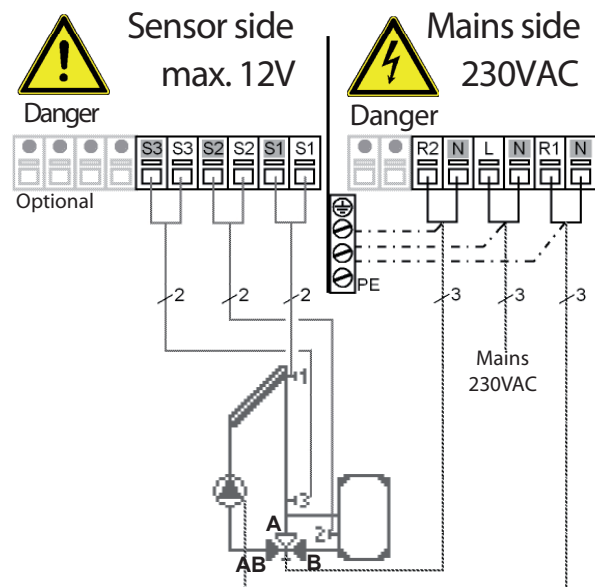

Low voltage - sensor connection

Terminal: connection for:

S1 (2×) sensor 1 collector

S2 (2×) sensor 2 storage tank

S3 (2×) sensor 3 before bypass

The polarity of the sensors is freely selectable.

Mains voltage - 230V 50Hz

Terminal: connection for:

L mains phase conductor L

N mains neutral conductor N

R1 pump L (speed)

N pump N

R2 zone valve L

N zone valve N

PE protective conductor (green-yellow)

Note: Actuating direction of the bypass valve:

R2 off = valve closed = flow direction B-AB = storage tank charging

R2 on = valve open = flow direction A-AB = bypass without storage tank charging



Caution

R1 output: for speed control of standard pumps, minimum load 20VA.

B 4 - Solar system with return line preheating

Sensor connection - max. 12V

Mains voltage - 230V 50Hz

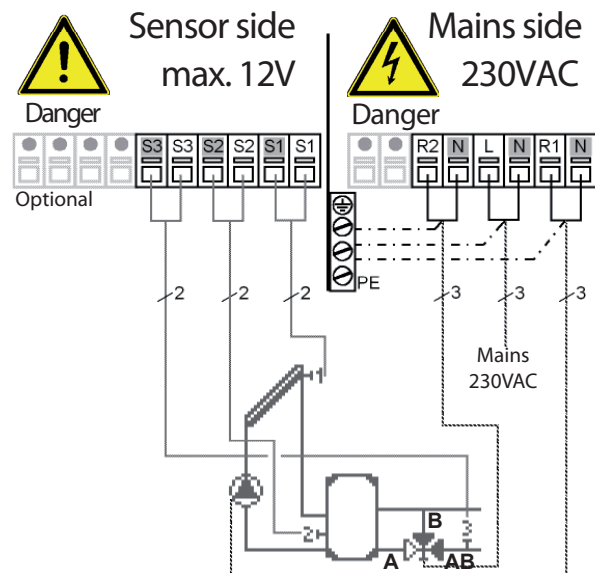

Low voltage - sensor connection

Terminal: connection for:

S1 (2×) sensor 1 collector

S2 (2×) sensor 2 storage tank

S3 (2×) sensor 3 heating circuit return

The polarity of the sensors is freely selectable.

Mains voltage - 230V 50Hz

Terminal: connection for:

L mains phase conductor L

N mains neutral conductor N

R1 pump L (speed)

N pump N

R2 zone valve L

N zone valve N

PE protective conductor (green-yellow)

Note: Actuating direction of the return-line zone valve:

R2 off = valve closed = flow direction B-AB = no backup heating

R2 on = valve open = flow A-AB through the storage tank



Caution

R1 output: for speed control of standard pumps, minimum load 20VA.

B 5 - Solar system with thermally stratified storage tank

Example: Heat gained from the solar system is stored either to the upper or to the lower tank part, depending on the temperature achievable from the solar system.

Sensor connection - max. 12V

Mains voltage - 230V 50Hz

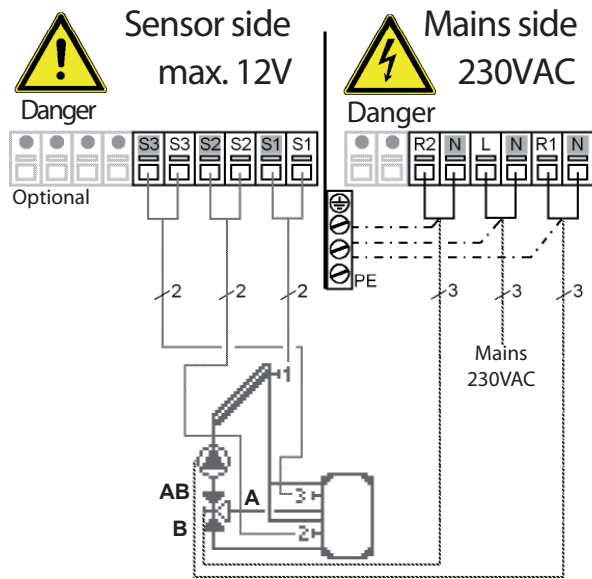

Low voltage - sensor connection

Terminal: connection for:

S1 (2×) sensor 1 collector

S2 (2×) sensor 2 storage tank lower

S3 (2×) sensor 3 storage tank upper

The polarity of the sensors is freely selectable.

Mains voltage - 230V 50Hz

Terminal: connection for:

L mains phase conductor L

N mains neutral conductor N

R1 pump L (speed)

N pump N

R2 zone valve L

N zone valve N

PE protective conductor (green-yellow)

Note: Actuating direction of zone valve:

R2 off = valve closed = flow direction AB-B = flow to storage tank lower (sensor 2)

R2 on = valve open = flow direction AB-A = flow to storage tank upper (sensor 3)



R1 output: for speed control of standard pumps, minimum load 20VA.

B 6 - Solar system with heat exchanger

Sensor connection - max. 12V

Mains voltage - 230V 50Hz

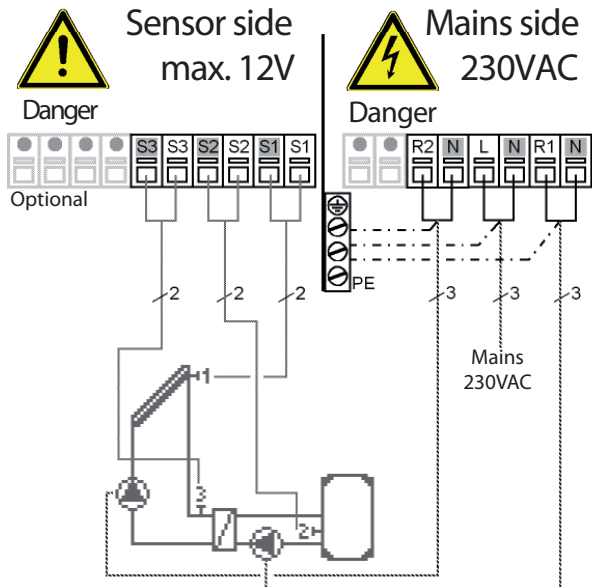

Low voltage - sensor connection

Terminal: connection for:

S1 (2×) sensor 1 collector

S2 (2×) sensor 2 storage tank lower

S3 (2×) sensor 3 before heat exchanger

The polarity of the sensors is freely selectable.

Mains voltage - 230V 50Hz

Terminal: connection for:

L mains phase conductor L

N mains neutral conductor N

R1 pump, secondary L

N pump, secondary N

R2 pump, primary L

N pump, primary N

PE protective conductor (green-yellow)



R1 output: for speed control of standard pumps, minimum load 20VA.

B 7 - Solar system with 2 collector fields (East/West) and zone valve

Sensor connection - max. 12V

Mains voltage - 230V 50Hz

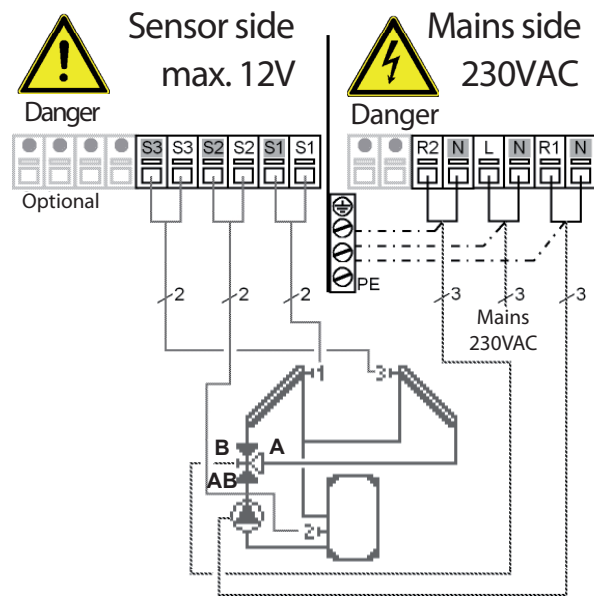

Low voltage - sensor connection

Terminal: connection for:

- S1 (2×) sensor 1 collector 1
- S2 (2×) sensor 2 storage tank
- S3 (2×) sensor 3 collector 2

The polarity of the sensors is freely selectable.

Mains voltage - 230V 50Hz

Terminal: connection for:

- L mains phase conductor L
- N mains neutral conductor N
- R1 pump L (speed)
- N pump N
- R2 zone valve L
- N zone valve N
- PE protective conductor (green-yellow)

Note: Actuating direction of zone valve:

R2 off = valve closed = flow direction AB-B = flow from collector field 1 (sensor S1)

R2 on = valve open = flow direction AB-A = flow from collector field 2 (sensor S3)



Caution

R1 output: for speed control of standard pumps, minimum load 20VA.

B 8 - Solar system with 2 collector fields and 2 pumps

Sensor connection - max. 12V

Mains voltage - 230V 50Hz

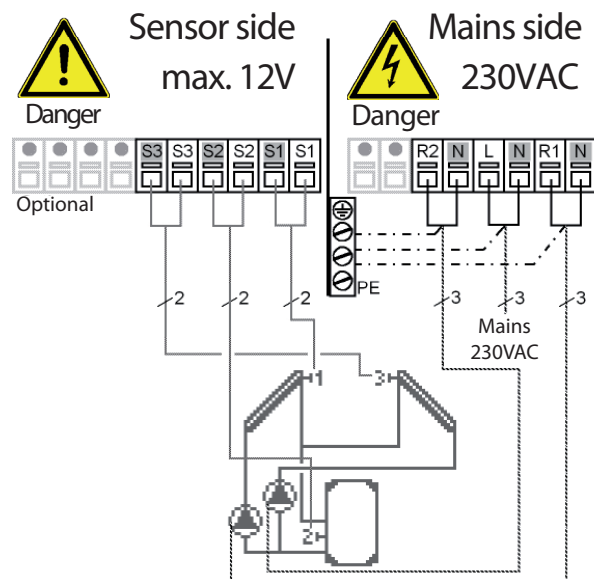

Low voltage - sensor connection

Terminal: connection for:

- S1 (2×) sensor 1 collector 1
- S2 (2×) sensor 2 storage tank
- S3 (2×) sensor 3 collector 2

The polarity of the sensors is freely selectable.

Mains voltage - 230V 50Hz

Terminal: connection for:

- L mains phase conductor L
- N mains neutral conductor N
- R1 pump (coll. 1) L
- N pump (coll. 1) N
- R2 pump (coll. 2) L
- N pump (coll. 2) N
- PE protective conductor (green-yellow)



Caution

R1 output: for speed control of standard pumps, minimum load 20VA.

B 9 - Solar system with 2 storage tanks and zone valve

Sensor connection - max. 12V

Mains voltage - 230V 50Hz

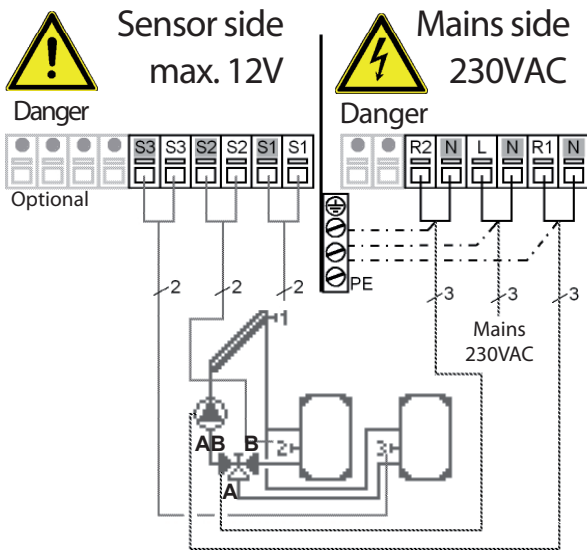

Low voltage - sensor connection

Terminal: connection for:

S1 (2×) sensor 1 collector

S2 (2×) sensor 2 storage tank 1

S3 (2×) sensor 3 storage tank 2

The polarity of the sensors is freely selectable.

Mains voltage - 230V 50Hz

Terminal: connection for:

L mains phase conductor L

N mains neutral conductor N

R1 pump L (speed)

N pump N

R2 zone valve L

N zone valve N

PE protective conductor (green-yellow)

Note: Actuating direction of zone valve:

R2 off = valve closed = flow direction B-AB = storage tank 1 charging (sensor S2)

R2 on = valve open = flow direction A-AB = storage tank 2 charging (sensor S3)



R1 output: for speed control of standard pumps, minimum load 20VA.

B10 - Solar system with 2 storage tanks and 2 pumps

Sensor connection - max. 12V

Mains voltage - 230V 50Hz

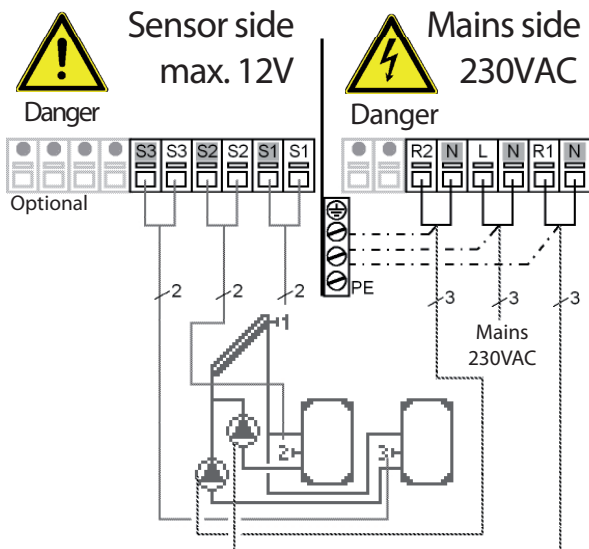

Low voltage - sensor connection

Terminal: connection for:

S1 (2×) sensor 1 collector

S2 (2×) sensor 2 storage tank 1

S3 (2×) sensor 3 storage tank 2

The polarity of the sensors is freely selectable.

Mains voltage - 230V 50Hz

Terminal: connection for:

L mains phase conductor L

N mains neutral conductor N

R1 pump (storage tank 1) L

N pump (storage tank 1) N

R2 pump (storage tank 2) L

N pump (storage tank 2) N

PE protective conductor (green-yellow)



R1 output: for speed control of standard pumps, minimum load 20VA.

B11 - Solar system with 2 storage tanks and heat exchange pump

Sensor connection - max. 12V

Mains voltage - 230V 50Hz

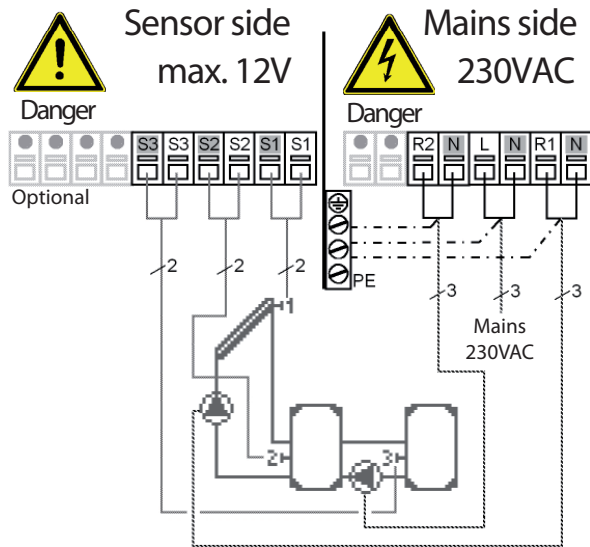

Low voltage - sensor connection

Terminal: connection for:

S1 (2×) sensor 1 collector

S2 (2×) sensor 2 storage tank 1

S3 (2×) sensor 3 storage tank 2

The polarity of the sensors is freely selectable.

Mains voltage - 230V 50Hz

Terminal: connection for:

L mains phase conductor L

N mains neutral conductor N

R1 pump L (speed)

N pump N

R2 pump (storage tank 2) L

N pump (storage tank 2) N

PE protective conductor (green-yellow)



R1 output: for speed control of standard pumps, minimum load 20VA.

B12 - Solar system with pool

Sensor connection - max. 12V

Mains voltage - 230V 50Hz

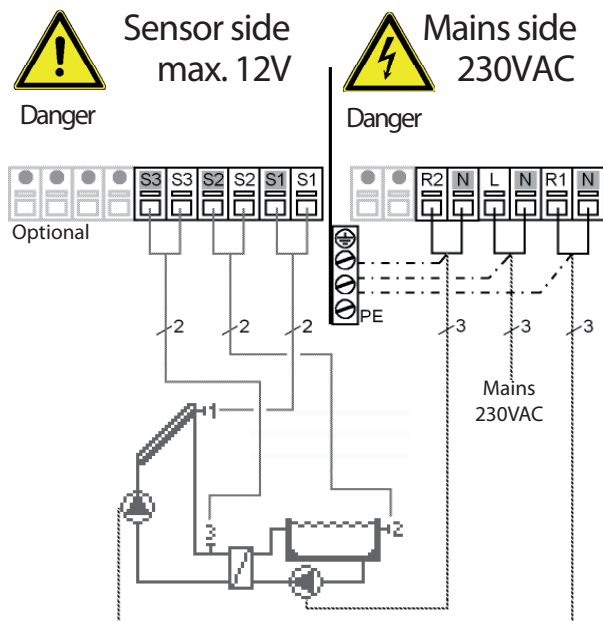

Low voltage - sensor connection

Terminal: connection for:

S1 (2×) sensor 1 collector

S2 (2×) sensor 2 pool

S3 (2×) sensor 3 before heat exchanger

The polarity of the sensors is freely selectable.

Mains voltage - 230V 50Hz

Terminal: connection for:

L mains phase conductor L

N mains neutral conductor N

R1 pump L (speed)

N pump N

R2 pool pump L

R1 pool pump N

PE protective conductor (green-yellow)



R1 output: for speed control of standard pumps, minimum load 20VA.

B13 - Solar system with pool and storage tank

Sensor connection - max. 12V

Mains voltage - 230V 50Hz

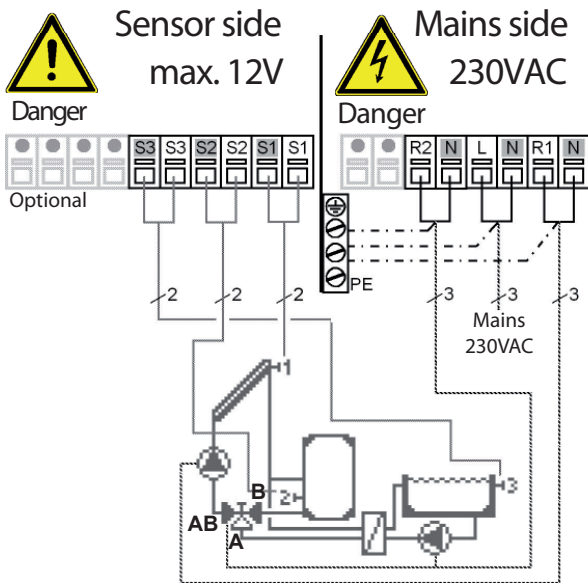

Low voltage - sensor connection

Terminal: connection for:

- S1 (2×) sensor 1 collector
- S2 (2×) sensor 2 storage tank
- S3 (2×) sensor 3 pool

The polarity of the sensors is freely selectable.

Mains voltage - 230V 50Hz

Terminal: connection for:

- L mains phase conductor L
- N mains neutral conductor N
- R1 pump L (speed)
- N pump N
- R2 pool pump + 3-way valve L
- N pool pump + 3-way valve N
- PE protective conductor (green-yellow)

Note: Actuating direction of zone valve:

- R2 off = valve closed = flow direction B-AB = storage tank charging (sensor S2)
- R2 on = valve open = flow direction A-AB = pool heating (sensor S3)



R1 output: for speed control of standard pumps, minimum load 20VA

B14 - Solar system + cooling 1

Sensor connection - max 12V

Mains voltage - 230V 50Hz

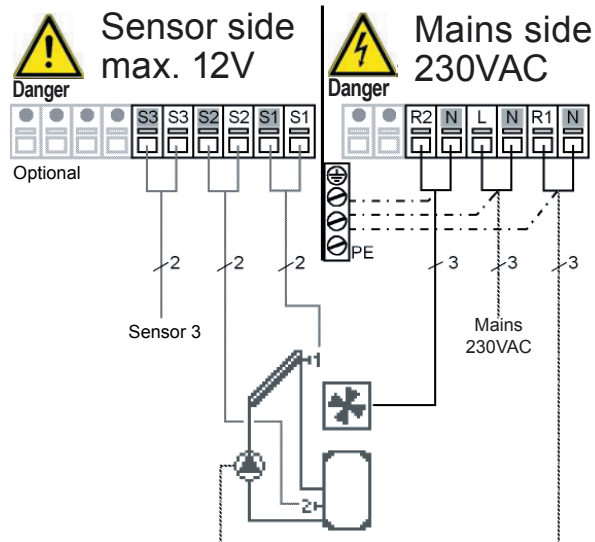

Low voltage - sensor connection

Terminal: connection for:

- S1 (2×) sensor 1 collector
- S2 (2×) sensor 2 storage tank
- S3 (2×) sensor 3

The polarity of the sensors is freely selectable.

Mains voltage - 230V 50Hz

Terminal: connection for:

- L mains phase conductor L
- N mains neutral conductor N
- R1 pump L (speed)
- N pump N
- R2 cooling L
- N cooling N
- PE protective conductor (green-yellow)

Description of cooling function - see chapter D 6.4.1



R1 output: for speed control of standard pumps, minimum load 20VA

B15 - Solar system + cooling 2

Sensor connection - max. 12V

Mains voltage - 230V 50Hz

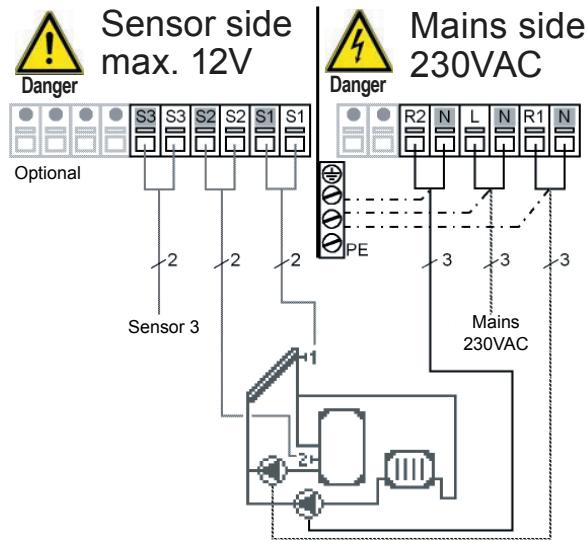

Low voltage - sensor connection

Terminal: connection for:

- S1 (2×) sensor 1 collector
- S2 (2×) sensor 2 storage tank
- S3 (2×) sensor 3

The polarity of the sensors is freely selectable.

Mains voltage - 230V 50Hz

Terminal: connection for:

- L mains phase conductor L
- N mains neutral conductor N
- R1 pump L (speed)
- N pump N
- R2 cooling pump L
- N cooling pump N
- PE protective conductor (green-yellow)

Description of cooling function - see chapter D 6.4.1



Caution

R1 output: for speed control of standard pumps, minimum load 20VA

B16 - Solar system + cooling 3

Sensor connection - max 12V

Mains voltage - 230V 50Hz

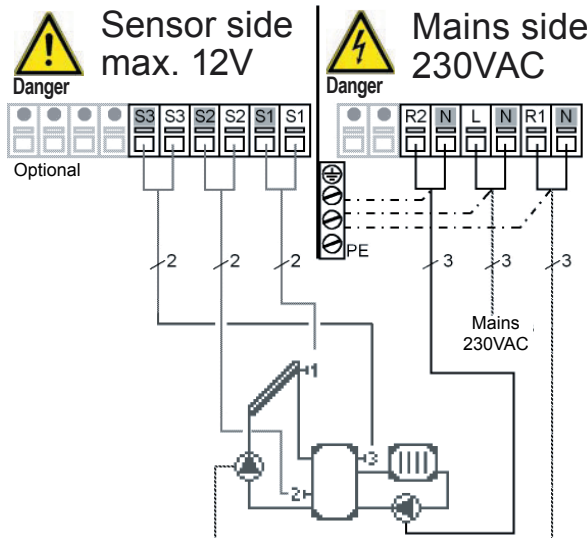

Low voltage - sensor connection

Terminal: connection for:

- S1 (2×) sensor 1 collector
- S2 (2×) sensor 2 storage tank
- S3 (2×) sensor 3

The polarity of the sensors is freely selectable.

Mains voltage - 230V 50Hz

Terminal: connection for:

- L mains phase conductor L
- N mains neutral conductor N
- R1 pump L (speed)
- N pump N
- R2 cooling pump L
- N cooling pump N
- PE protective conductor (green-yellow)

Description of cooling function - see chapter D 6.4.1



Caution

R1 output: for speed control of standard pumps, minimum load 20VA

B17 - Solar system + solid fuel boiler

Sensor connection - max. 12V

Mains voltage - 230V 50Hz

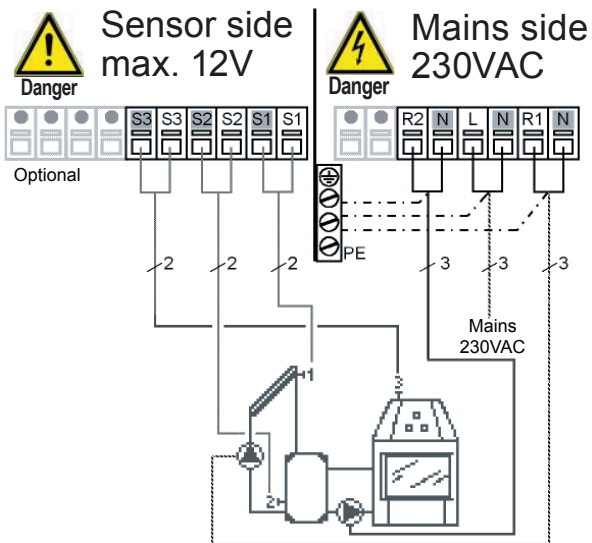

Low voltage - sensor connection

Terminal: connection for:

- S1 (2×) sensor 1 collector
- S2 (2×) sensor 2 storage tank
- S3 (2×) sensor 3 solid fuel boiler

The polarity of the sensors is freely selectable.

Mains voltage - 230V 50Hz

Terminal: connection for:

- L mains phase conductor L
- N mains neutral conductor N
- R1 pump L (speed)
- N pump N
- R2 boiler pump L
- N boiler pump N
- PE protective conductor (green-yellow)



R1 output: for speed control of standard pumps, minimum load 20VA

B18 - Solar system + zone valve + thermostat

Sensor connection - max 12V

Mains voltage - 230V 50Hz

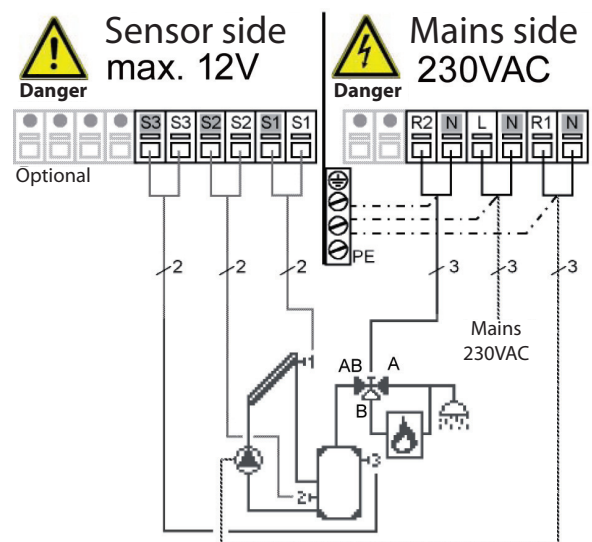

Low voltage - sensor connection

Terminal: connection for:

- S1 (2×) sensor 1 collector
- S2 (2×) sensor 2 storage tank lower
- S3 (2×) sensor 3 storage tank upper

The polarity of the sensors is freely selectable.

Mains voltage - 230V 50Hz

Terminal: connection for:

- L mains phase conductor L
- N mains neutral conductor N
- R1 pump L
- N pump N
- R2 valve L
- N valve N
- PE protective conductor (green-yellow)

Note: Actuating direction of zone valve:

R2 off = valve closed = flow direction B-AB = backup heating

R2 on = valve open = flow direction A-AB = no backup heating



R1 output: for speed control of standard pumps, minimum load 20VA

B19 - One temperature difference controller $1 \times \Delta T$ and one thermostat (no solar functions)

Sensor connection - max. 12V

Mains voltage - 230V 50Hz

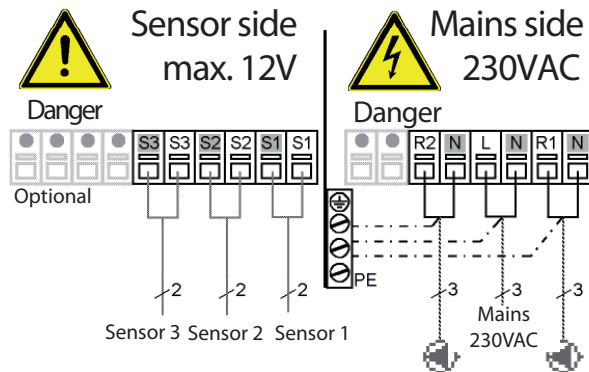

Low voltage - sensor connection

Terminal: connection for:

- S1 (2×) sensor 1 (control) source
- S2 (2×) sensor 2 (reference) consumer
- S3 (2×) sensor 3 (thermostat)

The polarity of the sensors is freely selectable.

Mains voltage - 230V 50Hz

Terminal: connection for:

- L mains phase conductor L
- N mains neutral conductor N
- R1 pump L (speed)
- N pump N
- R2 pump 2 L
- N pump 2 N
- PE protective conductor (green-yellow)

Brief description of switching function:egulátorem:

If temperature S1 > temperature S2, R1 pump relay switches.

The thermostat function works with sensor 3 and switches relay R2.



R1 output: for speed control of standard pumps, minimum load 20VA

B20 - Two temperature difference controllers $2 \times \Delta T$ (no solar functions)

Sensor connection - max. 12V

Mains voltage - 230V 50Hz

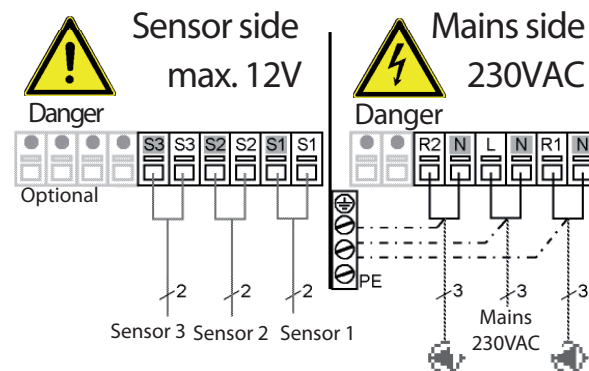

Low voltage - sensor connection

Terminal: connection for:

- S1 (2×) sensor 1
- S2 (2×) sensor 2
- S3 (2×) sensor 3

The polarity of the sensors is freely selectable.

Mains voltage - 230V 50Hz

Terminal: connection for:

- L mains phase conductor L
- N mains neutral conductor N
- R1 pump L (speed)
- N pump N
- R2 pump 2 L
- N pump 2 N
- PE protective conductor (green-yellow)

Brief description of switching function:

If temperature S1 > temperature S2, R1 pump relay switches.

If temperature S2 > temperature S3, R2 pump relay switches.



R1 output: for speed control of standard pumps, minimum load 20VA

C - Controller Use

C 1 - Display and input

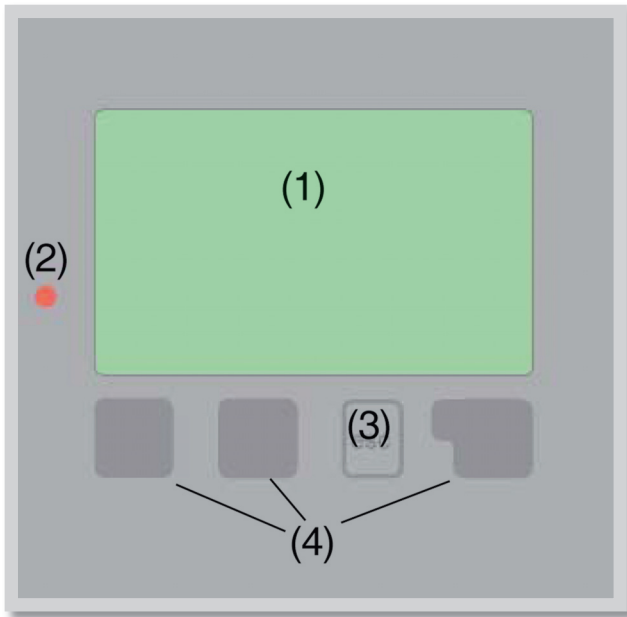

The display (1) shows graphic and text info on the hydraulic variant, set and measured values and other text info.



The LED lamp (2):

- lights up green -** if a relay is closed and the controller works right
- lights up red -** if the controller is set to automatic operation and all relays are open
- flashes slowly red -** if manual operation mode is set
- flashes quickly red -** if an error occurred

Examples of display symbols:

-  pump (rotates in operation)
-  valve (direction of flow black)
-  collector
-  storage tank
-  pool
-  temperature sensor
-  heat exchanger
-  warning/error message
-  new information available

Entries are made using four keys (3+4), which are assigned to different functions depending on the situation.

The „esc” key (3) is used to cancel an entry or to exit a menu.

If applicable there will be a request for confirmation as to whether the changes which have been made should be saved.

The function of each of the other three keys (4) is shown in the display line directly above the keys; the right-hand key generally has a confirmation and selection function.

Examples of key functions:

- +/- increase/decrease values
- ▼/▲ scroll menu up/down
- YES/NO confirm/reject
- Info additional information
- Back to previous screen

C 2 - Menu structure

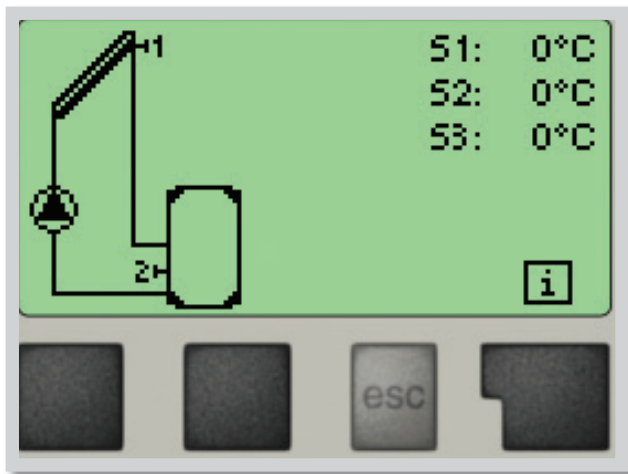

The graphics or overview mode appears when no key has been pressed for 2 minutes, or when the main menu is exited by pressing „esc“.

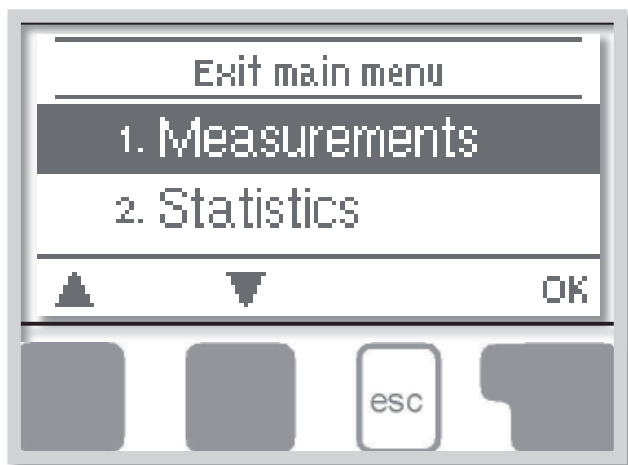

Pressing any key (4) in graphics or overview mode takes you directly to the main menu.

The following menu items are then available for selection there:

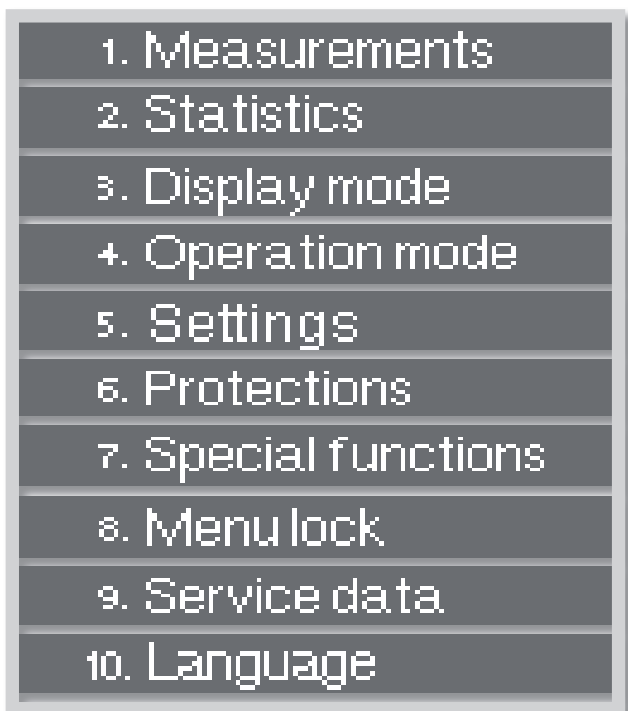

1. Current temperature values with explanations
2. Function control of the system with operating hours etc.
3. Select graphics mode or overview mode
4. Automatic mode, manual mode or switch unit off
5. Set parameters needed for normal operation
6. Solar and frost protection, recooling, antiseizing protection
7. Commissioning help, program selection, sensor calibration, clock etc.
8. Against unintentional setting changes
9. For diagnosis in the event of an error
10. Language selection

C 3 - Turning on for the first time



The first time the controller is turned on, language and clock need to be set.

After that a query appears as to whether you want to parameterize the controller using the commissioning help or not. The commissioning help can also be terminated or called up again at any time in the special functions menu. The commissioning help guides you through the necessary basic settings in the correct order, and provides brief descriptions of each parameter in the display.

Pressing the „**esc**“ key takes you back to the previous value so you can look at the selected setting again or adjust it if desired. Pressing the „**esc**“ more than once takes you back step by step to the selection mode, thus cancelling the commissioning help. Finally, menu

4.2 under operating mode „**Manual**“ should be used to test the switch outputs with the consumers connected, and to check the sensor values for plausibility. Then switch on automatic mode.

C 4 - Free commissioning

If you decide not to use the commissioning help, you should make the necessary settings in the following sequence:

- Menu 10. Language (see D10)
- Menu 7.2 Time and date (see D7.2)
- Menu 7.1 Program selection (see D7.1)
- Menu 5 Settings, all values (see D5)
- Menu 6 Protective functions if modifications are necessary (see D6)
- Menu 7 Special functions if additional changes are necessary (see D7)

Finally, menu 4.2 under operating mode „**Manual**“ should be used to test the switch outputs with the consumers connected, and to check the sensor values for plausibility. Then switch on automatic mode.



Observe the explanations for the individual parameters on the following pages, and check whether further settings are necessary for your application.

D - Parameter Settings

Measurement values menu 1

D 1 - Measurements

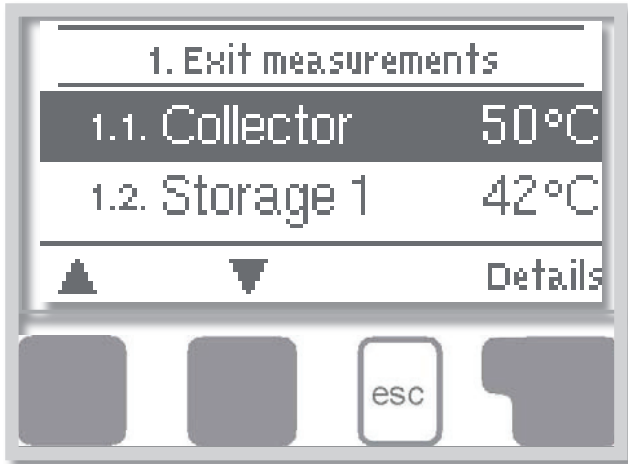

Menu „1. Measurements” serves to display the currently measured temperatures. What measurement values are displayed depends on the selected program and the specific controller model.

The menu is closed by pressing „esc” or selecting „Exit measurements”.

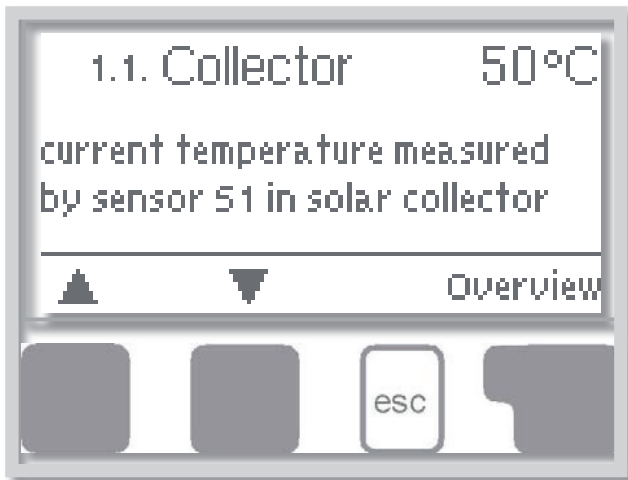

Selecting „Details” leads to a brief help text explaining the measurement values.

Selecting „Overview” or „esc” exits the Info mode.



If „Error” appears on the display instead of the measurement value, then there may be a defective temperature sensor or its wiring.

If the cables are too long or the sensors are not placed optimally, the result may be small deviations in the measurement values. In this case the display values can be compensated for using the function of sensor compensation - see Chapter D 7.3.

D 2 - Statistics



Menu „**2. Statistics**” is used for function control and long-term monitoring of the system.

The menu is closed by pressing „**esc**” or selecting „**Exit statistics**”.



For analysis of the system data it is essential that time is set accurately on the controller.



Please note that the clock does not continue to run if the mains voltage is interrupted, and must therefore be reset. Incorrect time set in Regulus SRS 3 controller may result in data being deleted, recorded incorrectly or overwritten.

D 2.1 - Operating hours menu 2.1

Display of operating hours of the solar pump connected to the controller; various time spans are available (last day, week, month, year).

D 2.2 - Average (temperature difference) ΔT menu 2.2

Display of the average temperature difference between the reference sensors of the solar system with the consumer switched on.

D 2.3 - Heat output menu 2.3

Display of the approximate heat output of the solar system. (Settings see D7.7)

D 2.4 - Graphic overview menu 2.4

This function provides a clearly-organized display of operating hours, average ΔT and heat output as a bar graph. Various time ranges are available. The two left-hand keys can be used to page through the data.

D 2.5 - Message log menu 2.5

Display of the last 10 events occurring in the system with indication of date and time. Errors (e.g. collector alarm) and operating states (e.g. anti-legionella function on) are displayed.

D 2.6 - Reset / clear menu 2.6

Resetting and deleting the individual analyses of Regulus SRS 3 controller. The function „**All statistics**” clears all analyses but not the error messages.

D 3 - Display mode

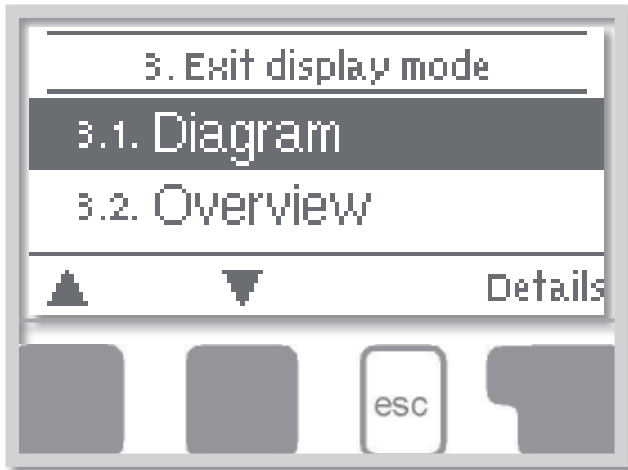

Menu „3. Display mode” is used to define the controller’s display for normal operation. This display appears whenever two minutes go by without any key being pressed. The main menu appears again when a key is pressed.

The menu is closed by pressing „esc” or selecting „Exit display mode”.

D 3.1 - Diagram menu 3.1

In graphics mode, the selected hydraulic systems are depicted with the measured temperatures and operating states of the connected valves and pumps.

D 3.2 - Overview menu 3.2

In overview mode, the measured temperatures and operating states of the connected consumers are shown in text form. No hydraulic system is shown.

D 3.3 - Alternating menu 3.3

In alternating mode the diagram mode and then the overview mode are active for 5 seconds at a time.

D 4 - Operation mode

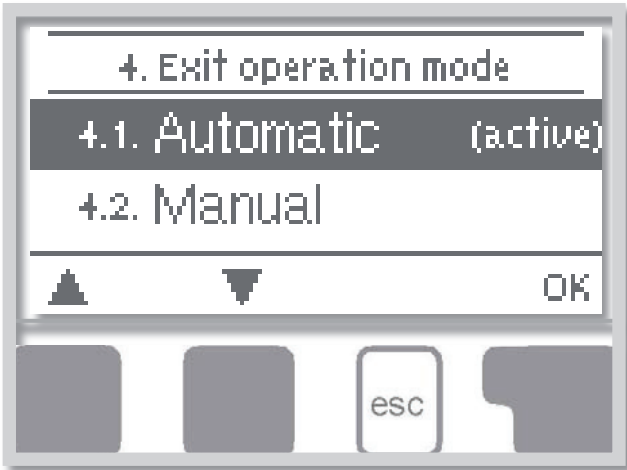

In menu „4. Operation mode” the controller can either be switched to automatic mode, switched off, or switched to a manual operating mode. The menu is closed by pressing „esc” or selecting „Exit operation mode”.



Never select other mode than automatic without reason. Long-term operation in another mode can lead to overheating of the solar collector, storage tank and shortening the lifetime of the solar liquid or other system components!

D 4.1 - Automatic menu 4.1

Automatic mode is the normal operating mode of the SRS 3 controller.



Caution

Only automatic mode provides proper controller function taking into account the current temperatures and the parameters that have been set!

D 4.2 - Manual menu 4.2



Danger

The manual mode is intended to be used by a technician when commissioning or checking the system. The relay and thus the connected pump, valve or heating rod are switched on and off by pressing a key, with no regard to the current temperatures and the parameters which have been set. The measured temperatures are also shown. Long-term operation in manual mode in current operation can lead to system damage or overheating of water in the storage tank!

D 4.3 - Off menu 4.3



Danger

When the operating mode „Off” is activated, all controller functions are switched off. This can lead, for example, to overheating of the solar collector or other system components. The measured temperatures are displayed.

D 4.4 - Fill system menu 4.4



Caution

This special operating mode is intended only for the filling procedure for a special „Drain Master System” with a fill level contact. It is not used in Regulus solar systems. However, if you activate it, be sure to terminate the function when finished!

After an interruption of the mains voltage the controller automatically returns to the last operating mode selected!

D 5 - Settings

The necessary basic settings required for the control function are made in menu „5. Settings”.

The menu is closed by pressing „esc” or selecting „Exit settings”.



Caution

Various settings can be made depending on the selection of hydraulic variant 1-20. An overview of the variants is shown in Table 5.14.

Often more conditions must be met simultaneously for the relay to switch, as it is obvious from the Table 5.14. (E.g. ΔT between a collector and storage tank, Min./max. collector temperature and max. storage tank temperature). When only one condition is met, the relay does not switch (e.g. ΔT might be reached but the collector temperature is still below T_{1min}).

D 5.1 - Tmin S1 menu 5.x = sensor S1 switch-on temperature

If this value is exceeded at sensor S1 and the other conditions as in Table 5.14 are also met, then the controller switches the associated pump and/or valve on. If the temperature at sensor S1 drops below this value by 5 °C, then the pump and/or the valve are switched off again.

Setting range: 0-99 °C / default setting: 20 °C

D 5.2 - Tmin S2 menu 5.x = sensor S2 switch-on temperature

If this value is exceeded at sensor S2 and the other conditions as in Table 5.14 are also met, then the controller switches the associated pump and/or valve on. If the temperature at sensor S2 drops below this value by 5 °C, then the pump and/or the valve are switched off again.

Setting range: 0-99 °C / default setting: 40 °C

D 5.3 - Tmin S3 menu 5.x = sensor S3 switch-on temperature

If this value is exceeded at sensor S3 and the other conditions as in Table 5.14 are also met, then the controller switches the associated pump and/or valve on. If the temperature at sensor S3 drops below this value by 5 °C, then the pump and/or the valve are switched off again.

Setting range: 0-99 °C / default setting: 20 °C

D 5.4 - Tmax S2 menu 5.x = sensor S2 switch-off temperature

If this value is exceeded at sensor S2, then the controller switches the associated pump and/or valve off. If sensor S2 temperature falls below this value again and the other conditions as in Table 5.14 are also met, then the controller switches the pump and/or valve on again.

Setting range: 0-99 °C / default setting: 60 °C



Danger

Temperature values which are set too high will allow higher solar heat accumulation but it shall be checked that all system components are resistant to high temperature and scalding protection is provided. Regulus solar systems are safe for heating water up to 95 °C.

D 5.5 Tmax S3 menu 5.x = sensor S3 switch-off temperature

If this value is exceeded at sensor S3, then the controller switches the associated pump and/or valve off. If sensor S3 temperature falls below this value again and the other conditions as in Table 5.14 are also met, then the controller switches the pump and/or valve on again.

Setting range: 0°-99 °C/default setting: 60 °C (in hydraulic variants with S3 default: Off)



Danger

Temperature values which are set too high will allow higher solar heat accumulation but it shall be checked that all system components are resistant to high temperature and scalding protection is provided. Regulus solar systems are safe for heating water up to 95 °C.

D 5.6 - ΔT R1**menu 5.x** = switch-on/switch-off temperature difference for relay R1

If this temperature difference between the reference sensors is exceeded and the other conditions as in Table 5.14 are also met, then the controller switches the pump on. When the temperature difference drops below ΔT R1 Off, then the pump is switched off again

Settings range: ΔT R1 4-20 °C, ΔT R1 off 2-19 °C. Default settings: ΔT R1 10 °C, ΔT R1 off 3 °C



Caution

1) Setting the temperature difference too big will lead to switching the circulation pump on and off due to uselessly high temperature difference between a collector and storage tank which could lead to a mild reduction of annual solar yield. It may also cause more frequent solar pump switching on and off (so called cycling). Selecting the right ΔT will depend on the size of the solar system, length of the solar piping and quality of pipe insulation. Generally spoken, the shorter the distance between a collector and a tank and the better pipe insulation, the lower value of ΔT can be selected, and vice versa.

2) Setting the temperature difference too small may lead to solar pump operating even under unfavorable conditions (no or little sunshine). Solar system then remains in operation even with minimum gain and the pump power consumption may be higher than the solar gains.

For most current solar systems the values of ΔT between 8 and 12 K are used.

Situations described in 1) and 2) may occur also if the sensors are improperly located or their compensation set to a wrong value.

Please refer to special rules described in Chapter D 7.9 when switching pumps with controlled speed.

D 5.7 - ΔT R2**menu 5.x** = switch-on/switch-off temperature difference for relay R2

If this temperature difference between the reference sensors is exceeded and the other conditions as in Table 5 are also met, then the controller switches the pump and/or the valve on. When the temperature drops below ΔT R2 Off, then the pump is switched off again.

Settings range: ΔT R2 4-20 °C, ΔT R2 Off 2-19 °C. Default setting: ΔT R2 10 °C, ΔT R2 Off 3 °C



Caution

1) Setting the temperature difference too big will lead to switching the circulation pump off even when the sun is still shining. Temperature increase in the collector will make the pump start again. The pump will then keep switching on and off.

2) The right ΔT value depends on the number and type of solar collectors and the flow rate of solar liquid set. If a too small temperature difference is set, the pump may run permanently. This may be caused by placing sensors differently in a collector and in a tank, improperly set sensor compensation... Even a small difference between the measured and real temperature will influence the controller.

D 5.8 - Tset S3**menu 5.x** = thermostat function at sensor S3

If the temperature at sensor S3 falls below this value, the relay R2 together with backup heating is switched on. If the temperature at sensor S3 exceeds this value plus hysteresis, the relay is switched off.

Settings range: Tset 0-99 °C / default setting: 60 °C



Caution

In Energy saving mode (D 5.16) other settings may apply

D 5.9 - Hysteresis**menu 5.x** = Hysteresis for thermostat function at sensor S3

Hysteresis value for backup heating on (see D 5.8 Tsetpoint S3 above)

If the Energy saving mode is active (see D 5.16), the system heats up until Tmin S3+hysteresis temperature is reached.

Setting range: Hysteresis 2 to 20 °C / default setting: 10 °C

D 5.10 - Priority sensor menu 5.x = charging priority in systems with two storage tanks

A setting must be made as to which storage tank (storage tank sensor) has priority for charging and will be charged first.

Setting range: Priority S2, S3 / default setting: S2



- A) The higher priority storage tank is always charged first.
- B) After the desired temperature (T_{maxSx}) is reached in the higher priority storage tank, charging is diverted to the lower priority storage tank.
- C) If the collector temperature does not enable charging the higher priority tank, and at the same time the temperature in the higher priority tank is above $T_{priority}$, then charging is diverted to the lower priority tank.
Note: $T_{priority}$ (=lower temperature limit for absolute priority, only the priority storage tank is charged below this limit)
- D) Until the priority tank reaches the desired temperature, charging of the lower-priority storage tank is interrupted at regular intervals to check whether the temperature increase at the collector can enable charging of the higher-priority storage tank.

Setting range: S2 or S3 / default setting: S2

Example: Setting:	Priority sensor = S2	$T_{priority} = 40\text{ °C}$
	Charging interruption = 10 min	Increase = 3 °C/min
	$T_{maxS2} = 60\text{ °C}$	$\Delta T R1 = 10\text{ °C}$

If the temperature at S2 is below 60 °C **S2** storage tank (higher priority) is charged

- A) If the temperature at S2 is above 60 °C
- B) Temperature difference between collector and S2 tank.... $S1-S2 < \Delta T R1$
and at the same time $S2 > 40\text{ °C}$ S3 storage tank (lower priority) is charged
- C) After 10 min. (*Charging interruption*) the solar pump(s) stop and the temperature increase is measured. If Increase $> 3\text{ °C/min}$., Interruption time is extended until the switching condition $S1-S2 < \Delta T R1$ for S2 storage tank is met.
If the increase is less than 3 °C/minS3 storage tank is charged

D 5.11 - Tpriority - Priority switching temperature menu 5.x = lower temperature limit for absolute priority
Charging the lower-priority tank is possible only after this temperature (Tpriority) is reached in the higher-priority storage tank.

Setting range: 0-90 °C / default setting: 40 °C

D 5.12 - Charging interruption menu 5.x = interruption of charging into the lower priority storage tank

The charging of the lower-priority storage tank is interrupted after this settable time in order to check whether the collector has reached a temperature level that allows charging in the higher-priority storage tank. If not, charging the lower-priority storage tank continues until the next interruption.

Setting range: 5-90 min. / default setting: 10 min.

D 5.13 - Increase menu 5.x = temperature increase during charging interruption

The temperature increase is measured during interruption in charging to the lower-priority storage tank. After 10 min. (Charging interruption) the solar pump(s) stop and the temperature increase is measured. If Increase > 3 °C/min., Interruption time is extended until the switching condition $S1-S2 < \Delta T R1$ for S2 storage tank is met.

If the temperature increase does not reach the value set (Increase), the interruption is terminated and the lower-priority tank continues being charged.

Setting range: 1-10 °C/min / default setting: 3 °C/min

- If the S2 temperature is below 40 °C, only the S2 (higher priority) storage tank is charged.
- If the S2 temperature is over 60 °C, only the S3 (lower priority) storage tank is charged.
- If the S2 temperature is between 40 and 60 °C and the condition $S1-S2 < \Delta T R1$ is met (collector heat output is sufficient), the S2 (higher priority) storage tank is charged.
- If the S2 temperature is between 40 and 60 °C and the condition $S1-S2 < \Delta T R1$ is not met (collector heat output is not sufficient), charging is diverted to S3 (lower priority) storage tank and the collector is checked at regular intervals whether the temperature increase is sufficient. If yes, charging returns to the priority storage tank (S2).

D 5.14 - Thermostat periods

Set the desired periods of time when the thermostat should be active. 2 periods can be set per day, settings can also be copied to other days. Outside the set times the thermostat is switched off.

Setting range: od 00:00 to 23:59 / default setting: 06:00 to 22:00

D 5.15 - Party function



With the party function the storage temperature is heated up once to the set temperature (Tset) regardless of the thermostat timer. The party mode is enabled by pressing the „esc“ key for 3 seconds in the main menu. While this mode is active, the system heats up to the set value Tset S3 (or Tmin S3 in energy saving mode), unattached to preset thermostat times. The mode is ended once the required temperature is reached.

D 5.16 - Energy saving mode

The energy saving mode sets the temperature limit when the additional storage tank heating (e.g. with a heating rod) via R2 is switched on. In any case, this additional heating can be switched on during thermostat operation only.

- If solar heat is available, additional heating is switched on when Teco S3 is reached and heats up to Teco+hysteresis.
- When no solar heat is available, additional heating is switched on when Tset S3 is reached and heats up to Tset S3+hysteresis, i.e. like in normal mode.

Additional heating mode. Setting range: ON, OFF / default setting: OFF

D 5.17 - Teco S3**Minimum temperature S3 in Energy saving mode**

If the temperature at sensor 3 falls below this value and the thermostat function is active (see 5.14), additional heating via relay R2 is switched on.

Additional heating is on until Teco S3 + hysteresis is exceeded.

Teco

Setting range: 0 °C - 99 °C / default setting: 20 °C

Example: Limitation of additional heating temperature in storage tank with el. heating rod.

Hydraulic variant B18 Solar system + zone valve + thermostat shall be selected.

Relay switching the el. heating rod shall be wired to R2.

1) With the default setting valid, i.e. energy saving mode off ($T_{set\ S3} = 50\text{ °C}$, $hysteresis = 10\text{ °C}$, *thermostat operation period = 06:00 to 22:00*), the el. heating rod heats the storage tank to a temperature between 60 °C (on) and 70 °C (off) during the period from 6:00 to 22:00, independent of solar heat.

2) If the **Energy saving mode (5.16)** is active and $Teco = 20\text{ °C}$, then:

If solar heat is available, then between 6:00 and 22:00 el. heating rod heats the storage tank to 20 °C (on) - 30 °C (off).

If no solar heat is available, then the el. heating rod heats the storage tank to 60 °C (on) - 70 °C (off) between 6:00 and 22:00, like in normal mode.

D 5.18 - Table: Programs (hydraulic variants) with associated settings for Regulus SRS3 Controller:

The table lists the settings corresponding to the specific programs (hydraulic variants). The reference sensors are labeled S1, S2, S3. The relays are labeled R1, R2. Select a column with the desired hydraulic variant. All the conditions listed in that column must be fulfilled for the relay to switch.

Example: Hydraulic variant No. 5. The following conditions must be fulfilled at the same time for R1 relay to switch: Tmin S1, Tmax S2, Tmax S3, ΔT R1, conditions Priority, Tpriority

Hydraulic variant No.	1	2	3	4	5	6	7	8	9	10	11	12	13	14	15	16	17	18	19	20
Tmin S1	S1 =>R1+R2	S1 =>R1	S1 =>R1	S1 =>R1	S1 =>R1	S1 =>R2	S1 =>R1	S1 =>R1	S1 =>R1	S1 =>R1+R2	S1 =>R1	S1 =>R1	S1 =>R1	S1 =>R1	S1 =>R1	S1 =>R1	S1 =>R1	S1 =>R1	S1 =>R1	S1 =>R1
Tmin S2				S2 =>R2							S2 =>R2									S2 =>R2
Tmin S3							S3 =>R1+R2	S3 =>R2									S3=>R2			
Tmax S2	S2 =>R1+R2	S2 =>R1	S2 =>R1+R2	S2 =>R1	S2 =>R1	S2 =>R1+R2	S2 =>R1+R2	S2 =>R1+R2	S2 =>R1	S2 =>R1	S2 =>R1	S2 =>R1+R2	S2 =>R1	S2=>R1	S2=>R1	S2=>R1	S2=>R1+R2	S2=>R1	S2 =>R1	S2 =>R1
Tmax S3				S3 =>R2	S3 =>R1+R2				S3 =>R1+R2	S3 =>R2	S3 =>R2		S3 =>R1+R2							S3 =>R2
Δ T R1	S1/S2 =>R1+R2	S1/S2 =>R1	S1/S2 =>R1 S3/ S2 =>R2	S1/S2 =>R1	S1/S2 =>R1 S1/S3 =>R1+R2	S1/S2 =>R2 S3-S2 =>R1	S1/S2 =>R1 S3/S2 =>R1+R2	S1/S2 =>R1	S1/S2 =>R1 S1/S3 =>R1+R2	S1/S2 =>R1	S1/S2 =>R1	S1/S2 =>R1 S3/ S2 =>R2	S1/S2 =>R1 S3/ =>R1+R2	S1/ S2=>R1	S1/ S2=>R1	S1/ S2=>R1	S1/ S2=>R1	S1/ S2=>R1	S1/S2 =>R1	S1/S2 =>R1
Δ T R2				S2/S3 =>R2				S3/S2 =>R2		S1/S3 =>R2	S2/S3 =>R2						S3/ S2=>R2			S2/S3 =>R2
Tset S3																S3=>R2		S3=>R2		S3 =>R2
Hysteresis																S3=>R2		S3=>R2		S3 =>R2
Priority					S2 or S3 =>R1/R2				S2 or S3 =>R1/R2	S2 or S3 =>R1/R2			S2 or S3 =>R1/R2							
Tpriority					S2 or S3 =>R1/R2				S2 or S3 =>R1/R2	S2 or S3 =>R1/R2			S2 or S3 =>R1/R2							

D 6 - Protective functions

Menu „**6. Protections**” can be used to activate and set various protective functions.



These functions do not under any circumstances replace safety elements in solar systems!

The menu is closed by pressing „**esc**” or selecting „**Exit protections**”.

D 6.1 - Antiblock protection

menu 6.1 / 6.1.1 - 6.1.2

Pump seizing protection using regular short turning on a pump or a valve. Seizing may occur after prolonged inactivity of valves or pumps. If this protection is activated, then the controller switches the relay in question and the connected consumer on every day at 12:00 or on Sundays at 12:00 (for weekly settings) for 5 seconds in order to prevent the pump and/or the valve from sticking after an extended stationary period.

Setting range: R1: daily, weekly, off / default setting: Off

Setting range: R2: daily, weekly, off / default setting: Off

D 6.2 - Frost protection

menu 6.2 / 6.2.1 - 6.2.2

Frost protection prevents freezing of collectors and solar system filled with water instead of antifreeze fluid. In order to save energy, please leave it off for Regulus solar systems.

A two-stage frost protection function is available. In stage 1 the controller switches the pump on for 1 minute every hour if the collector temperature drops below the set value „**Frost stage 1**”. If the collector temperature drops further to the set value „**Frost stage 2**”, the controller switches the pump on continuously. If the collector temperature then exceeds the value „**Frost stage 2**” by 2 °C, then the pump switches off again.

Frost protection setting range: on, off/default setting: off

Frost protection stage 1 setting range: from -25 °C to 10 °C or off/default setting: 7 °C

Frost protection stage 2 setting range: from -25 °C to 8 °C or off/default setting: 5 °C



This function causes energy loss via the collector!

As Regulus solar systems are filled with antifreeze fluid, the antifreeze protection shall remain off.

D 6.3 - System protection

menu 6.3 / 6.3.1 - 6.3.5

If „SProt Ton” is exceeded at the collector, the pump is switched off. The collector is let at high temperature. The pump is activated again when the temperature drops below „SProt TOff”.

Automatic shutdown - settings range: On / Off / Default: on

Settings range: SProt Ton 60 °C to 150 °C / Default: 120 °C

Settings range: SProt TOff 50 °C to Ton -5 °C / Default: 115 °C



Collectors do not get cooled and stay heated. This may result in limited lifetime of the solar fluid. If you use this function, please check your solar fluid regularly.

D 6.4 - Collector protection

If „CP Ton“ is exceeded at the collector sensor, the pump is switched on in order to cool the collector down. The pump turns off when the collector temperature falls below „CP Toff“ or the temperature „CP Tmax storage“ is exceeded in the storage or pool. In systems with 2 storage tanks only the lower-priority tank or pool is used for collector cooling.

Collector protection - Setting range: On, Off / default setting: Off

Settings range: CP Ton 60 °C to 150 °C / Default: 110 °C

Settings range: CP Toff 50 °C to CP Ton -5 °C / default setting: 100 °C

Settings range: CP Tmax storage 0 °C to 140 °C / default setting: 90 °C



Caution

When collector protection is active, the storage or pool may get heated to a high temperature!

D 6.4.1 - Cooling functions menu 6.4.1

The hydraulic variants are set in menu „7.1 Program selection“

Hydraulic Variant D.14 Solar + cooling 1:

If „CProt Ton“ is exceeded at S1 (collector), the cooler at R2 is switched on until the temperature drops to „CProt Toff“. If the storage tank exceeds „CProt Tmax storage“, the pump at R1 is switched off.

Hydraulic Variant D.15 Solar + cooling 2:

If „CProt Ton“ is exceeded at S1, the cooler at R2 is switched on. If the storage tank exceeds „CProt Tmax storage“, R1 is switched off with R2 still running to keep on cooling. If the temperature at S1 drops to „CProt Toff“, cooling is switched off.

Hydraulic Variant D.16 Solar + cooling 3:

If „CProt Ton“ is exceeded at S1, the pump at R1 is switched on to cool the collector by heating up the storage tank.

If the storage tank exceeds „CProt Tmax storage“, R1 pump is switched off. Once the storage tank at S3 exceeds Tset S3, cooling at R2 is switched on until „TsetS3“- hysteresis is reached.

D 6.5 - Col.- Alarm menu 6.5

If this temperature is exceeded at the collector sensor when the solar pump is on, a warning is triggered. A red LED starts flashing and a warning message is shown in the display.

Setting range: Collector alarm off, on / default setting: off

Setting range: Col. alarm 60 °C to 300 °C / Default setting: 150 °C

D 6.6 - Recooling menu 6.6

At the end of a sunny day the temperature in a storage tank may easily reach high values. In order to prevent further temperature increase the next day, excess energy can be released into the air via collectors under cloudy conditions or after sunset.

If the temperature in the storage tank exceeds the value „**Recool Tsetpoint**” and the collector is at least by 20 °C cooler than the storage tank, the solar pump starts. The storage tank is then cooled down until the „**Recool Tsetpoint**” is reached. In systems with two storage tanks the setting applies to both storage tanks.

Setting range: Recooling off, on / default setting: off

Setting range: Recooling Tsetpoint from 0 °C to 99 °C / default setting: 70 °C



Caution

This function enables to release excess heat from the storage tank considerably and without solar fluid overheating, via piping and collectors into the ambient air. It is recommended to keep activated. Combinable with protective solar function.

D 6.7 - Anti-Legionella menu 6.7

With the „**AL function**” activated the controller makes it possible to heat the storage tank up once at certain intervals the („**AL frequency**”) to a higher temperature („**AL Tsetpoint S2**”), assuming that the energy source allows this.

Setting range: **AL function:** On or Off / default setting: Off

Setting range: **AL Tsetpoint S2:** from 60 °C to 99 °C / default setting: 70 °C

Setting range: **AL frequency:** from 1 to 28 days / default setting: 7 days

AL function: Shows the last time the AL function was active



Caution

The anti-Legionella function is switched off at delivery. This function is only relevant for storage tanks where sensor 2 is installed. Whenever heating-up has been carried out with the anti-Legionella function switched on, an information message with the date appears on the display.



Danger

*During the anti-Legionella function the storage tank is heated up over the set value „**Tmax S2**”!*



Danger

To provide complete protection against Legionella bacteria, the function must be applied to all the tanks and sufficient energy must be available for safe heating the system up to the necessary temperature. This protection is efficient only where a high temperature is present, that is why the circulation pump shall be switched on at the same time, ensuring piping protection as well.

D 7 - Special functions



Menu „7. Special functions” is used to set basic items and expanded functions.



Danger

Menu „7. Special functions” is used to set basic items and expanded functions.

The menu is closed by pressing „esc” or selecting „Exit special functions”.

D 7. 1 - Program selection menu 7.1

The suitable hydraulic variant for the specific application is selected and set here (see Chapter A2 Hydraulic variants). The associated diagram can be displayed by pressing „info”.

Setting range: Program selection 1-20 / default setting: 1



Caution

Normally the program selection is made only once during initial commissioning by the specialist. Incorrect program selection can lead to wrong operation and unpredictable errors.

D 7. 2 - Time & date menu 7.2

This menu is used to set the current time and date.



Caution

For analysis of the system data it is essential for the time to be set accurately on the controller. Please note that the clock does not continue to run if the mains voltage is interrupted, and must therefore be reset.

D 7. 3 - Sensor calibration menu 7.3 / 7.3.1 - 7.3.3

Deviations in the temperature values displayed, for example due to cables which are too long or sensors which are not positioned optimally, can be compensated for manually here. The settings can be made for each individual sensor in steps of 0.5 °C.

Setting range: Offset S1...S3 -100 °C to +100 °C / default setting: 0 °C



Caution

Settings are only necessary in special cases at the time of initial commissioning by the specialist. Incorrect measurement values can lead to wrong operation and unpredictable errors.

D 7. 4 - Commissioning help menu 7.4

Starting the commissioning help guides you in the correct order through the basic settings necessary for commissioning, and provides brief descriptions of each parameter in the display.

Pressing the „esc” key takes you back to the previous value so you can look at the selected setting again or adjust it if desired. Pressing the „esc” more than once takes you back to the selection mode, thus cancelling the commissioning help. (see also C3 Commissioning help).



Caution

May only be started by a specialist during commissioning! Observe the explanations for the individual parameters in these instructions, and if further settings are necessary for your application, set them after the help is finished.

D 7. 5 - Reset to factory settings menu 7.5

All of the settings that have been made can be reset, thus returning the controller to its delivery state.



Caution

The entire parameterization, analyses, etc. of the controller will be lost irrevocably. The controller must then be commissioned and set once again.

D 7. 6 - Expansions menu 7.6

This menu can only be selected and used if additional options or expansions have been built into the controller.

The associated supplementary installation, mounting and operation instructions are then included with the specific expansion.

D 7. 7 - Heat quantity menu 7.7 / 7.7.1 - 7.7.5

A simple heat metering function for basic system control can be activated in this menu. Set the type and concentration of the antifreeze fluid and its flow rate read from the mechanical flowmeter (in the pump station). A deviation value for heat metering can be also set by modifying „ **ΔT Offset**”.



Remember that the hydraulic variant does not change. Settings in this menu are used for heat calculation only and should be set according to the real system. Resulting data is only approximate value for function control!

Heat metering menu 7.7.1

Activate or deactivate the heat metering function.

Settings range: On / off / default setting: Off

AF type menu 7.7.2

Adjust the type of antifreeze used in the system. Kolekton Super Plus is of propylene type.

Setting range: Ethylene / Propylene / default setting: Ethylene

Glycol portion menu 7.7.3

Adjust the percentage of glycol that has been used in the system. Kolekton Super Plus has a concentration of 50 %.

Setting range: 0-60 % / default setting: 40 %

Flow rate menu 7.7.4

Adjust the flow rate read from the flowmeter (in the pump station). The flowmeter shows flow rate in l/minute. For l/hour just multiply the number with 60 (e.g. 4 l/min = 240 l/hour).

Setting range: 10-5000 l/h / default setting: 500 l/h

ΔT Offset menu 7.7.5

Calculation of heat metering is based on the temperature of the collector and storage where measuring takes place.

For a proper calculation, the temperature of the feed and return lines of the solar system shall be used. The temperatures of the tank sensor and of the solar return line are usually almost identical. Possible deviations of these temperatures can be compensated using the value **ΔT Offset** .

Example: Displayed collector temp. 40° C, displayed storage temp. 30° C, ΔT is 40-30=10 °C. Measured flow temp. 39° C, measured return temp. 31° C, ΔT is 93-31=8 °C. This means an offset setting of -20 % (Displayed ΔT 10K, actual ΔT 8K which is by 20 % less => -20 % correction value.)

Setting range: -50 % to +50 % / default setting: 0 %

D 7.8 - Start aid function menu 7.8 / 7.8.1 - 7.8.3

With some vacuum tube collectors, it may occur that the sensor is often not at the hottest location. This function turns on the solar pump for a while which helps moving the heated solar liquid to the sensor for real temperature check.

When the start help is activated, the following sequence is carried out:

If the temperature at the collector sensor increases by the value specified under „**Increase**” within one minute, then the solar pump is switched on for the set „**Purging time**” so that the medium to be measured can be moved to the collector sensor. If this still does not result in a normal switch-on condition, then the start help function is subject to a 5-minute lockout time.

Start help setting range: on, off / default setting: off

Purging time setting range: 2-30 sec. / default setting: 5 sec.

Increase setting range: 1 °C - 10 °C / default setting: 3 °C / min.



In Regulus tube collectors the sensor sheath is placed in optimum position inside the collector and the start help function is not needed.

D 7.9 - Pump speed control

menu 7.9

If the speed control is activated, the SRS3 makes it possible to vary the speed of standard pumps at relay R1.

**Danger**

This function should only be activated by a specialist. Depending on the pump and pump stage used, the minimum speed should not be set too low, because otherwise the pump or the system may be damaged. The information provided by the relevant manufacturer must also be observed! If in doubt, the min. speed and the pump stage should generally be set to high rather than too low.

D 7.9.1 - Variants of speed control

menu 7.9.1

Off: There is no speed control. The connected pump is only switched on or off with full speed.

Variant V1 - Control to the set ΔT , starts from max. speed:

The pump starts at max. speed. After the purging time (D 7.9.2) the controller switches to the set max. speed. (D 7.9.4).

If the temperature difference ΔT between the reference sensors (collector and storage tank) is less than the set value, then the speed is decreased by one stage after the **Sweep time** (D 7.9.3) elapses. If the temperature difference between the reference sensors is greater than the set value, then the speed is increased by one stage after the **Sweep time** (D 7.9.3) elapses.

If the controller has adjusted the speed of the pump down to the smallest stage and the ΔT between the reference sensors is ΔT off, the pump is switched off.

Variant V2 - Control to the set ΔT , starts from min. speed:

The pump starts at max. speed. After the purging time (D 7.9.2) the controller switches to the set min. speed. (D 7.9.5).

If the temperature difference ΔT between the reference sensors (collector and storage tank) is greater than the set value, then the speed is increased by one stage after the **Sweep time** (D 7.9.3) elapses.

If the temperature difference between the reference sensors is less than the set value, then the speed is decreased by one stage after the **Sweep time** (D 7.9.3) elapses. If the controller has adjusted the speed of the pump down to the smallest stage and the ΔT between the reference sensors is below $T\Delta_{off}$, the pump is switched off.

Variant V3 - Control to a constant collector temperature, starts from min. speed:

The pump starts at max. speed. After the purging time (D 7.9.2) the controller switches to the set min. speed. If the temperature at the reference sensor (collector) is greater than the Setpoint (D 7.9.6), then the speed is increased by one stage after the Sweep time (D 7.9.3) expires.

If the temperature at the reference sensor (collector) is less than the Setpoint, then the speed is decreased by one stage after the Sweep time (D 7.9.3) expires. If the controller has adjusted the speed of the pump down to the smallest stage and the ΔT between the reference sensors is less than 1/3 of the required ΔT , the pump is switched off.

Setting range: V1, V2, V3, off / default setting: off

Variant V4 - for 2 storage tanks

When the valve is set toward the primary storage, speed control works as in V3 (see above). When the valve is set toward the secondary storage, speed control works as in V2.

Setting range: V1, V2, V3, off / default setting: off

D 7.9.2 - Purging time menu 7.9.2

During this time the pump starts up at its full speed (100 %) to ensure reliable starting. Only after this purging time does the pump run with speed control and switches to the max. or min. speed, depending on the variant set.

Setting range: from 5 to 600 seconds / default setting: 8 s

D 7.9.3 - Sweep time menu 7.9.3

The control time is used to determine the delay for speed control in order to avoid large temperature oscillations as much as possible. Longer delay should be set for systems with less collectors and long pipes from collectors to the storage tank. Shorter delay then for larger systems with a shorter distance to the storage tank. The meaning of the parameter is described above (D 7.9.1).

Setting range: Sweep time 1-15 min. / default setting: 4 min.

D 7.9.4 - Max. speed menu 7.9.4

The maximum starting speed of the pump at relay R1 is specified here.

Setting range: 70-100 % / default setting: 100 %



The indicated percentages are guide values that may vary to a greater or lesser extent depending on the system, pump and pump stage.

D 7.9.5 - Min. speed menu 7.9.5

The minimum starting speed of the pump at relay R1 is specified here.

Setting range: from 30 to max. speed -5% / default setting: 50 %



The indicated percentages are guide values that may vary to a greater or lesser extent depending on the system, pump and pump stage.

D 7.9.6 - Setpoint menu 7.9.6

This value is the control setpoint for variant 3. If the value at the collector sensor drops below the Setpoint, the speed is reduced. If it rises above the Setpoint, the speed is increased.

Setting range: 0 - 90 °C / default setting: 60 °C

When adjusting the min. speed, also the Sweep time shall be adjusted!

Setting the Sweep time: The Sweep time shall be long enough for the solar pump to move the solar medium at min. speed round the solar system (the liquid runs one round).

Set the Variant 3 of speed control and the Setpoint (7.9.6) to 0 °C. Set the Sweep time (7.9.3) to 15 min. and the Purging time (7.9.2) to 5 sec.

After starting the system, wait for the temperature to stabilize, for about 15 min. At the 15th minute the speed will increase. Measure time from that moment and follow the temperature at the collector sensor. It will start sinking after a while. Wait for another 15 minutes and note down the collector temperature each minute. The time needed for the collector temperature to calm down after the speed change is the min. time to be set as the Sweep time.

D 8 - Menu lock

Menu „**8. Menu lock**” can be used to secure the controller against unintentional changing of the set values.

The menu is closed by pressing „**esc**” or selecting „**Exit menu lock**”.

The menus listed below remain completely accessible despite the menu lock being activated, and can be used to make adjustments if necessary:

- D 1 - Measurement values
- D 2 - Statistics
- D 3 - Display mode
- D 7.2 - Time&date
- D 8 - Menu lock
- D 9 - Service values

To lock the other menus, select „**Menu lock on**”. To enable the menus again, select „**Menu lock off**”.

Setting range: on, off/default setting: off



Caution

It is advisable to keep the lock activated in order to prevent unintentional changes by a user.

D 9 - Service values

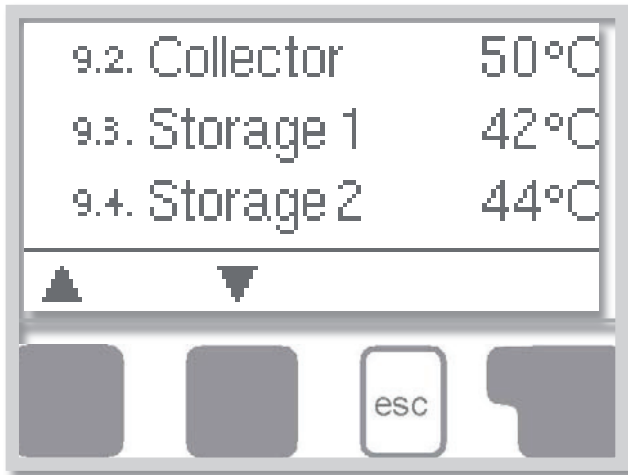

The menu „9. Service values” can be used for remote diagnosis by a specialist in the event of an error etc.



Caution

When you note down data from the Service values Menu at the time when an alarm or error occurs, this might help your technician to solve the problem. The data may be entered e.g. into the following table.

The menu can be closed at any time by pressing „esc”.

9.1.	
9.2.	
9.3.	
9.4.	
9.5.	
9.6.	
9.7.	
9.8.	
9.9.	
9.10.	
9.11.	
9.12.	
9.13.	
9.14.	
9.15.	
9.16.	
9.17.	
9.18.	
9.19.	
9.20.	
9.21.	
9.22.	
9.23.	
9.24.	
9.25.	
9.26.	
9.27.	
9.28.	
9.29.	
9.30.	

9.31.	
9.32.	
9.33.	
9.34.	
9.35.	
9.36.	
9.37.	
9.38.	
9.39.	
9.40.	
9.41.	
9.42.	
9.43.	
9.44.	
9.45.	
9.46.	
9.47.	
9.48.	
9.49.	
9.50.	
9.51.	
9.52.	
9.53.	
9.54.	
9.55.	
9.56.	
9.57.	
9.58.	
9.59.	
9.60.	

Note: ADC1 to 3 are internal data of temperature transducer 1 to 3.

D 10 - Language

Menu „**10. Language**” can be used to select the language for the menu guidance. This is queried automatically during initial commissioning. The controller involves English, German, Italian, Polish and Czech language versions.

E - Defects and Maintenance

E 1 - Error and info messages

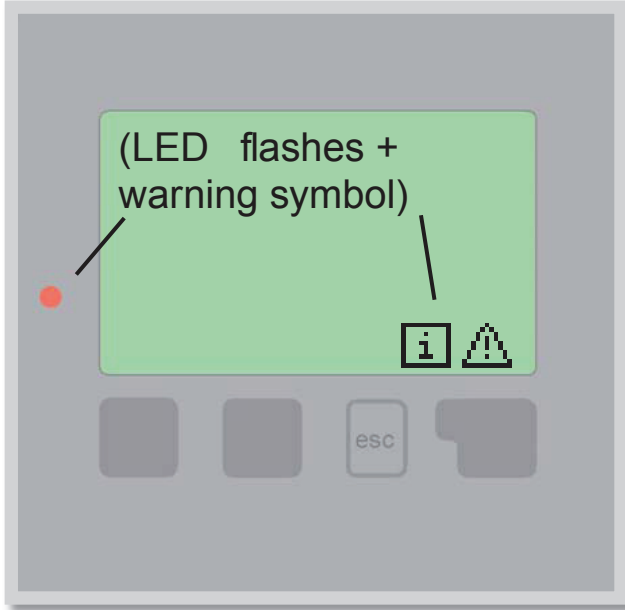

If the controller detects a malfunction, the red light flashes and the warning symbol also appears in the display. If the error is no longer present, the warning symbol changes to an info symbol and the red light no longer flashes.

To obtain more detailed information on the error, press the key under the warning or info symbol. Do not try to deal with this yourself. Consult a specialist in the event of an error!

Possible error messages:

Sensor x defective

Collector alarm

Night circulation

Restart

Time&date

Notes for the specialist:

Means that either the sensor, the sensor input at the controller or the connecting cable is/was defective. (Resistance table see chap. A6)

Means that the collector has risen/rose above the temperature set under menu 6.3.1 (chap. 6.3)

Means that the solar pump is/was in operation between 23:00 and 04:00. (Exception see D 6.4)

Means that the controller was restarted, for example due to a power failure. Check the date&time!

This message appears automatically after a mains failure because the time&date have to be checked, and reset if necessary.

E 2 - Replacing the fuse



Repairs and maintenance may only be performed by a specialist. Before working on the unit, switch off the power supply and secure it against being switched on again! Check for the absence of power!

Only use the supplied spare fuse or a fuse of the same design with the following specifications: T2A 250V.

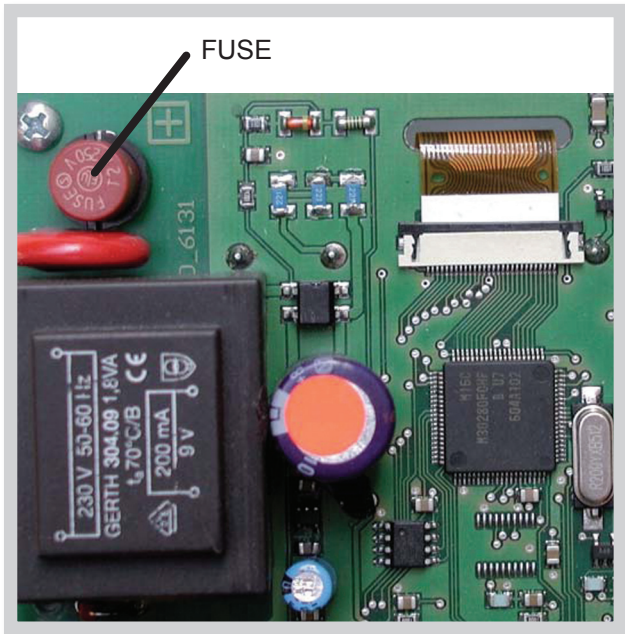

Fig. 3.1.1

If the mains voltage is switched on and the controller still does not function or display anything, then the internal device fuse may be defective. In that case, disconnect the device, open it, remove the old fuse and check it. Exchange the defective fuse for a new one, locate the external source of the error (e.g. pump) and exchange it. Then first recommission the controller and check the function of the switch outputs in manual mode as described under D 4.2.

E 3 - Maintenance

In the course of the general annual maintenance of your heating system you should also have the functions of the controller checked by a specialist and have the settings optimized if necessary.

Performing maintenance:

- Check the date and time (see D 7.2)
- Assess/check plausibility of analyses (see D 7.4)
- Check the error memory (see D 7.5)
- Verify/check plausibility of the current measurement values (see D 6)
- Check the switch outputs/consumers in manual mode (see D 9.2)
- Poss. optimize the parameter settings

E 4 - Useful hints and tricks



Instead of setting the flow rate for the system using a flow rate limiter, it is better to adjust the flow rate using the switch on the pump and by means of the „max. speed” setting on the controller (see D 7.9.4). This saves electricity!



The service values (see D 9) include not only current measurement values and operating states, but also all of the settings for the controller. Write the service values down just once after commissioning has been successfully completed.



In the event of uncertainty as to the control response or malfunctions the service values are a proven and successful method for remote diagnosis. Write the service values down (see D 9) at the time that the suspected malfunction occurs. Send the service value table by fax or e-mail with a brief description of the error to the specialist.



In program 1 „Solar system with storage tank” the mechanical relay R2 switches together with the speed-controlled output R1. Relay output R2 can be used to operate larger loads up to 460VA (pumps, valves or auxiliary relays).



In program 13 „Solar system with storage tank and pool” the charging of the pool, e.g. for winter operation, can be switched off using a simple function. To do this, simply press and hold the „esc” key down for several seconds on the diagram/overview screen. A message appears on the display as soon as the pool is switched off or when the pool is switched on again.



Programs 19 + 20 „Universal ΔT controller” are suitable, for example, for hydraulic variants with solid-fuel boiler, follow-on storage tank charging, storage tank heat exchange, heating circuit return raising, etc



The Operating hours displayed in the „Analysis” menu are solar operating hours. This therefore only takes into account hours in which the solar pump is active. In the universal programs 19 + 20 the times refer to relay R1.



To protect against loss of data, record any analyses and data that are particularly important to you at regular intervals.

E 5 - Disposal

IMPORTANT INFORMATION ON DISPOSAL IN COMPLIANCE WITH THE EUROPEAN DIRECTIVE 2002/96/ES

European Directive 2002/96/EC requires that the equipment bearing this symbol on the product and/or its packaging must not be disposed of with unsorted municipal waste. The symbol indicates that this product should be disposed of separately from regular household waste streams. It is your responsibility to dispose of this and other electric and electronic equipment via designated collection facilities appointed by the government or local authorities. Correct disposal and recycling will help prevent potential negative consequences to the environment and human health. For more detailed information about the disposal of your old equipment, please contact your local authorities, waste disposal service, or the shop where you purchased the product.



WEEE registration number: 02771/07-ECZ

04/2010



REGULUS spol. s r.o.
Do Koutů 1897/3
143 00 Praha 4

<http://www.regulus.eu>
E-mail: sales@regulus.cz