

ENG



NBE PELLET SYSTEM

RTB - ready to burn



CONTENTS:

Dear Customer.

Thank you for purchasing this NBE product which is designed and manufactured to the highest standards in the EU. In order for you to get the most out of your product, we strongly recommend that you carefully read this manual prior to installation and operation. In the event that you encounter any difficulties during installation or operation, we recommend that you first refer to this manual or the information provided in the support section found on www.nbe-global.com.

Note: Help text for all menus parameters can be accessed by selecting **?** in the v13 app found on your wireless tablet.

! Save this manual, so you always have it available if you ever need it.

Page 3:	Warnings.
Page 4:	Technical Data: RTB
Page 5:	Technical Data: BS+
Page 6:	Technical Data: Burners
Page 7-9:	Boiler Room Design
Page 10-12:	Installation Diagrams
Page 13:	Installation of the Boiler
Page 14:	RTB Pellet Hoppers
Page 15:	BS+ Pellet Hoppers
Page 16:	Vacuum Transport
Page 17:	Wiring Diagram-Controller Print
Page 18:	Wiring Diagram – Extension Module
Page 19:	Electrical Connection Scheme
Page 20:	Optional Equipment.
Page 21-22:	Connecting to the Internet.
Page 23:	Cloud Service.
Page 24:	First Time Start-Up.
Page 25:	Service Maintenance.
Page 26-27:	Troubleshooting.
Page 28:	Preventing Flue Gas Condensation.
Page 29-35:	Tablet Menu Structure
Page 36:	Warranty.
Page 37:	CE Declaration of Conformity.
Page 38:	Notes.



WARNINGS:



Never handle the auger, blower; nor should you crawl in the hopper when the system is powered. There will be no warning prior to the activation of these components. The boiler must not be operated without properly securing the ash can and lid.



The system is provided with an electrical current of 110/230V-50/60Hz. An improper installation or improper repair can cause life-threatening electrical shock. Electrical connections must be performed by a person with the right skills and training. Performance of electrical installation must be carried out in COMPLIANCE with the relevant local rules.

Always disconnect the system from the electrical supply prior to starting maintenance work or servicing. The system must be connected to a separate electrical circuit, which is equipped with the proper circuit breaker and earth leakage breaker.



The boiler must be mounted to a functioning chimney with adequate draft. In the event that you smell smoke or see any other indication of improper draft of the chimney, all operation of your system must cease immediately and must remain so until a solution to the draft problem has been resolved. Continuing operation may result in death or injury.

Always read the manual before installing and / or repairing of the system. If in doubt, seek professional help.



As the control system is constantly being updated and new features / experiences are being added, it is the user's responsibility to keep the manuals and maintenance manuals updated. New updated manuals can be downloaded from www.nbe-global.com



Open top covers etc. with extreme caution. When the boiler is in operation, there is a risk of high temperature below the top covers, which can cause burns. Avoid handling the boiler while it is in operation. Never open the ash tray while the boiler is in operation.

The system must be operated by skilled individuals. Contact your dealer if you are in doubt as to the safe operational use of the boiler.



The tablet controller's menu structure supported by the help texts found in the tablet app itself. Due to continuous updates and new features, it is recommended to browse the controller thoroughly prior to use and to receive an overview of all functions, etc. by your installer.

This manual must be kept at the boiler!

TECHNICAL DATA: RTB

Produkt Name	RTB 10	RTB 10 VAC	RTB 16	RTB 16 VAC	RTB 30	RTB 30 VAC	RTB 50	RTB 50 VAC	RTB 80
Nominal Performance	11 kW	11 kW	17 kW	17 kW	25 kW	25 kW	48 kW	48 kW	78kW
Minimum Performance	3 kW	3 kW	5,5 kW	5,5 kW	7,5 kW	7,5 kW	14 kW	14 kW	23 kW
Nominal Efficiency	93,9%	93,9%	91,1%	91,1%	91,4%	91,4%	93,6%	93,6%	93,6%
Minimum Efficiency	90,5%	90,5%	92,4%	92,4%	92,7%	92,7%	94,6%	94,6%	93,9%
Power Consumption (Nominal)	37W	37W	40W	40W	90W	90W	168W	168W	125W
Power Consumption (Minimum)	24W	24W	20W	20W	34W	34W	82W	82W	69W
EN303-5:2012 Klasse	5	5	5	5	5	5	5	5	5
Controller Version:	V13	V13	V13	V13	V13	V13	V13	V13	V13
Width (mm) (only boiler)	506	506	506	506	652	652	762	762	962
Depth (mm)	862	862	862	862	862	862	1114	1114	1296
Height (mm)	1055	1710 * 1982**	1055	1710* 1982**	1055	1710 * 1982**	1225	1880* 2152**	1518
Chimney (mm)	100	100	100	100	130	130	150	150	180
Weight (kg)	162	194	162	194	179	214	390	430	580
Water volume (liter)	36	36	36	36	48	48	78	78	105
Ash can (liter)	31	31	31	31	38	38	60	60	60
Forward/Return/Filling	¾"	¾"	¾"	¾"	¾"	¾"	1"	1"	5/4"
Test # 300-ELAB-	2042	2042	2045	2045	2064	2064	2179	2179	2216
* Boiler Height + Vacuum hopper **Boiler Height + Vacuum hopper + vacuum cyclone									

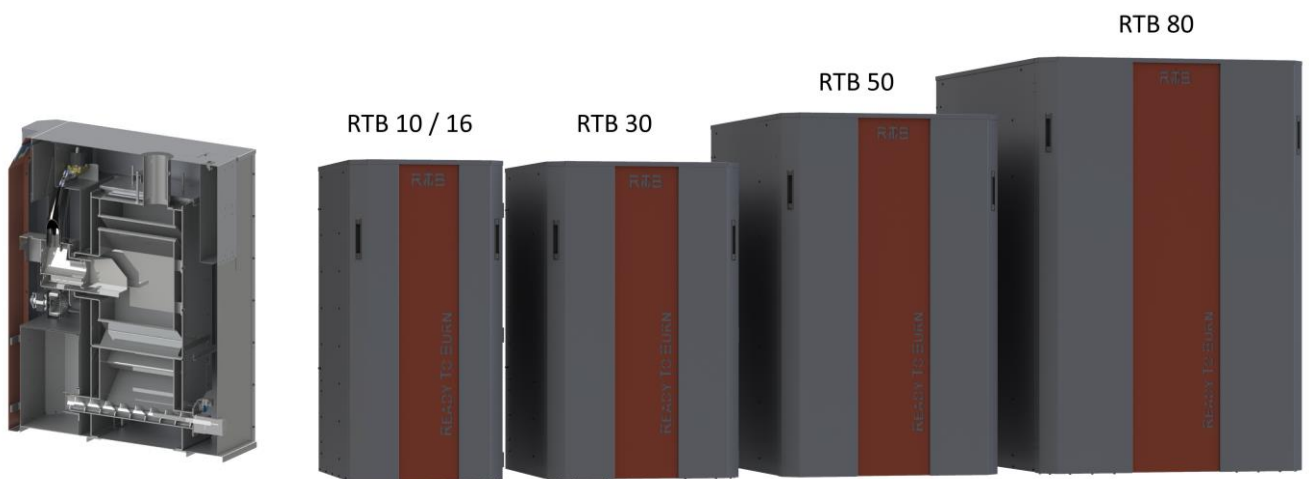

TECHNICAL DATA: BS+

Product Name	BS+ 10	BS+ 16	BS+ 25
Nominal Performance	12 kW	16 kW	23 kW
Minimum Performance	3 kW	5 kW	7 kW
Nominal Efficiency	95,0%	95,0%	95,0%
Minimum Efficiency	95,1%	94,3%	92,9%
Power Consumption (Nominal)	39W	52W	66W
Power Consumption (Minimum)	23W	25W	27W
EN303-5:2012 Klasse	5	5	5
Controller Version:	V13	V13	V13
Width (mm) (only boiler)	490	490	490
Width including 280l hopper	980	980	980
Width including 380l hopper	1240	1240	1240
Boiler Depth (mm)	969	969	969
Boiler Height (mm) *incl. Hopper	1113 / *1220	1113 / *1220	1113 / *1220
Chimney (mm)	130	130	130
Weight (kg)	162	163	165
Water capacity (liter)	36	36	36
Ash can capacity (liter)	25	25	25
Forward/Return/Filling	¾"	¾"	¾"
Test # 300-ELAB-	2052	ADM. APPROVED	2054



TECHNICAL DATA: BURNER

10 kW burner:
Upto 60 kg/day
37 watt/hr
Weight: 10 kg

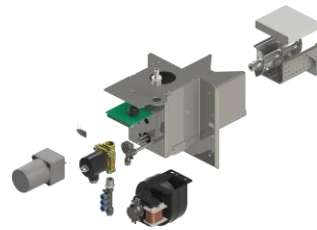

16 – 24 kW burner:
Upto 110 kg/day
40 watt/hr
Weight: 12 kg

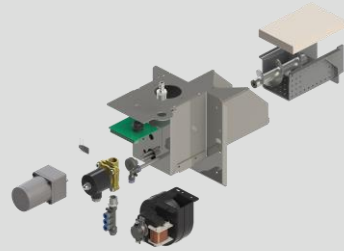

30 kW burner:
Upto 150 kg/day
90 watt/hr
Weight: 15 kg

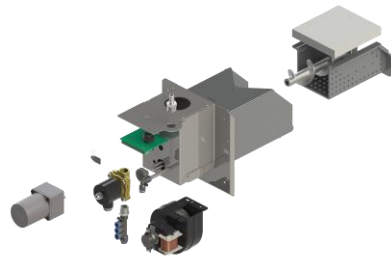

50 kW burner:
Upto 200 kg/day
215 watt/hr
Weight: 30 kg

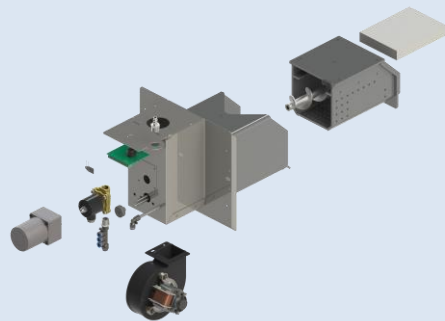

80 kW burner
Upto 350kg/day
300 watt/hr
Weight: 40kg

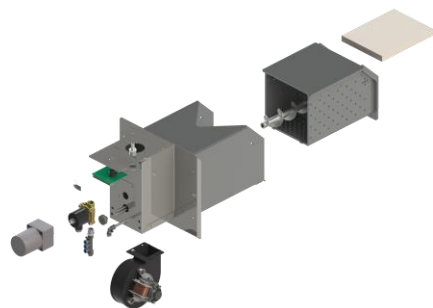

BOILER ROOM DESIGN:

The boiler room for biomass boilers must be installed in accordance with the rules set forth by your local building codes, environmental authorities, and labor inspectorate. If you are in doubt on how to set up your boiler room, we recommend that you contact your local certified RTB dealer for guidance.

1. Wall and ceiling.
2. Distance to the wall.
3. Floor.
4. Area and Lightning.
5. Chimney.
6. Air.
7. Water Faucet.
8. Fuel.
9. Prohibited Liquids and Materials in Boiler Room.
10. Permit, Notification and Inspection.



1. Wall and Ceiling.

Ceiling surfaces must be constructed with at least Class 1 surface material.

If the ceiling surface happens to be the underside of the roof, the material must be made of non-combustible materials. Wall surfaces must be constructed of at least a Class 2 surface material.

2. Distance to the wall.

Distance from the boiler or flue pipe to any combustible material should be large enough of a distance to prevent temperatures from reaching an excess of 80 C. This requirement applies even if the combustible material is covered with non-flammable material. If the distance is greater than 500 mm, the distance requirement is typically satisfied.

3. Floor.

Floors should consist of (or be covered with) non-combustible material under and around the boiler of a distance of at least 300mm from the boiler sides, and 500 mm from the boiler's front (i.e. the side where the ash is removed).

4. Area and Lightning.

The boiler room and area around the heating system must be large enough to allow for easy operation, cleaning, and maintenance of the heating system and boiler room.

There must be adequate lighting so that operation and maintenance can be performed safely.

5. Chimney.

The chimney must be of a design, aperture area, and height that provides adequate draft conditions for the proper exiting of flue gasses. The height of the chimney must also be controlled to ensure that there is sufficient draft for chimney smoke to exit. The chimney draft is created by negative pressure resulting from hot smoke that is buoyant; thus causing the smoke to rise up through the chimney.

WARNING: *If there is not enough draft in the chimney, the smoke will not properly rise and will instead seep out through small cracks; causing toxic smoke to seep into the house.*

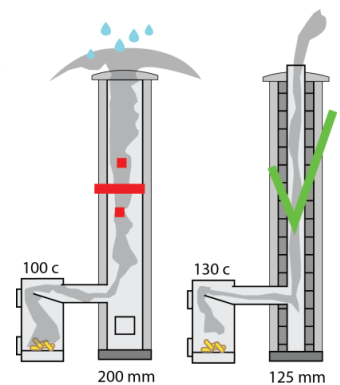

BOILER ROOM DESIGN:

The internal diameter of the chimney must be sufficient enough for the amount of flue gasses the chimney has to lead away. If the internal diameter is too small, this will prevent the smoke from exiting fast enough due to the large resistance in the chimney. This could cause the smoke to turn back; thus allowing for toxic fumes to enter into the house. Simultaneously, the pellet fuel may not be completely burned, due to the lack of oxygen for combustion. This can cause traces of tar like soot to sit in the chimney and create what is called creosote, which increases the risk of chimney fire.

The chimney opening must also not be too large since cold air can enter the chimney from the top. When the chimney becomes cooled, condensation can occur and develop soot inside the chimney. Soot is mostly a cosmetic problem, because it can penetrate through the chimney and cause ugly brown splotches to appear on the walls inside the house.

In addition, it is important that the chimney protrudes high enough above the roof so the smoke does not bother the surrounding houses. Environmental authorities have the possibility of prosecution if there are neighbors that complain about the smoke or odor.

What are the common signs that the chimney is not working?

- Light sensor is sooty or melted.
- Smoke in the hopper.
- Warm drop shaft.
- Smoke billows out of the fan or boiler during start-up.

If you have any problems with your chimney, it is a good idea to keep a "diary" of any draft problem; as draft problems are often associated with wind in certain directions.

Wind blowing on one side of the house can cause under pressure on the other side of the house.

Overpressure and under pressure will try to balance out – even through a chimney if possible. It is a good idea to ask your chimney sweeper about the size of the chimney and flues, the location of chimney cleaning doors, and whether it is required to have steps on the roof. He will also perform a fire prevention inspection.

6. Air

The pellet boiler should be able to get enough air for combustion. This can be achieved if the pellet boiler is installed in a room which is equipped with a sliding window with an adjustment bracket, an adjustable air vent from the outside, or by providing combustion chamber air through a duct from the outside. The area amount of the fresh air valve should generally be the same as the internal diameter of the chimney. It should also be mounted on the same side as the chimney to compensate for any pressure differences.

Note: that drum dryers, range hoods, or oil burner in the same room, all use high pressure blowers, that steal the air in the room.

7. Water tap

There must be a tap in the boiler room.

If the boiler output is less than 60 kW, a powder extinguisher is sufficient (at least 5 kg).

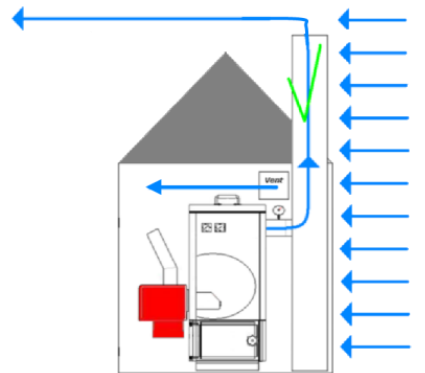
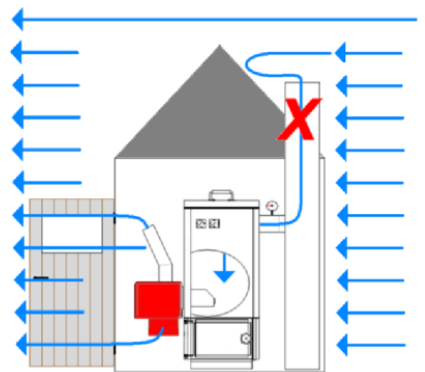

BOILER ROOM DESIGN:

8. Fuel.

The pellets must be pure wood, 6-8 mm, max. 8 % water.

Materials with glue, paint, wood paint or plastics shall not be burned.

If the fuel storage is greater than 0,75 m3, the boiler system and fuel storage must be located in a separate fire cell with at least one BD30 door to the other room.

If the fuel storage or hopper is placed in the open or under a shelter, there may be minimum distances to the building that should be observed. Exposed fuel may not be in the boiler room, except logs.

Do not exceed 4,75 m3 fuel in the boiler room, including fuel storage and usage storage.

9. Prohibited liquids and materials in boiler room.

The boiler room must be kept clean and contain no combustible materials nor flammable liquids (except oil for oil burners).

The floor must be kept free of spilled fuel, dust and combustible waste as well as waste from other activities in the room.

Any burning embers must be extinguished with water and transported to a secure storage location in the open.

10. Permit, notification and inspection.

Building permit:

You must obtain building permit if the burner is situated in a building that is part of the Building Regulations 1995 (commercial buildings); though not for animals and farm buildings.

Notification:

The heating system must be reported to the local council and registered with the chimney sweep.

Inspection:

The chimney sweeper will regularly supervise your biofuel boiler.

If the chimney sweeper becomes aware of any illegality under the rules for fireplaces and chimneys in the building code, he may notify the local council if the owner does not change the illegal conduct.

Insurance:

You must notify your insurance company about your biomass system.

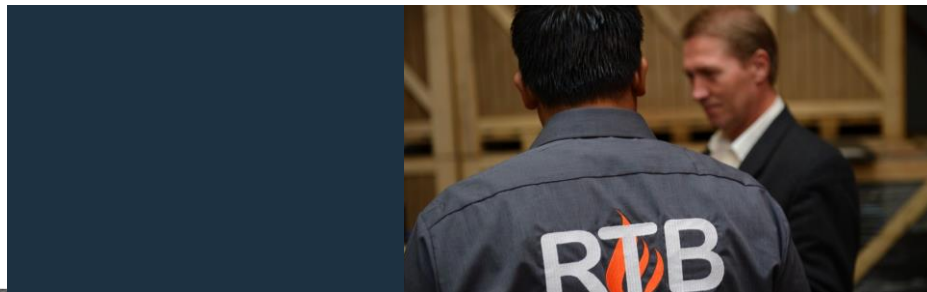
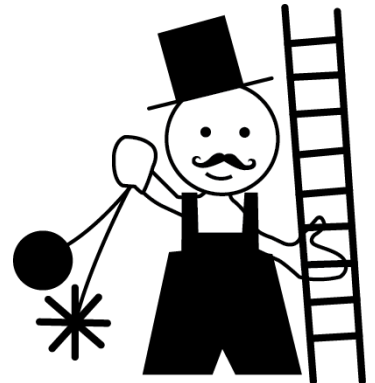

INSTALLATION DIAGRAMS:

A properly executed installation ensures that the system functions properly. Both national/local guidelines and requirements must always be observed. The boiler can be installed on a pressurized system up to max 2.5 bar.

1. Simple

Return water control with mechanical flow via adjustable shunt.

You should also have some type of control for the DHW

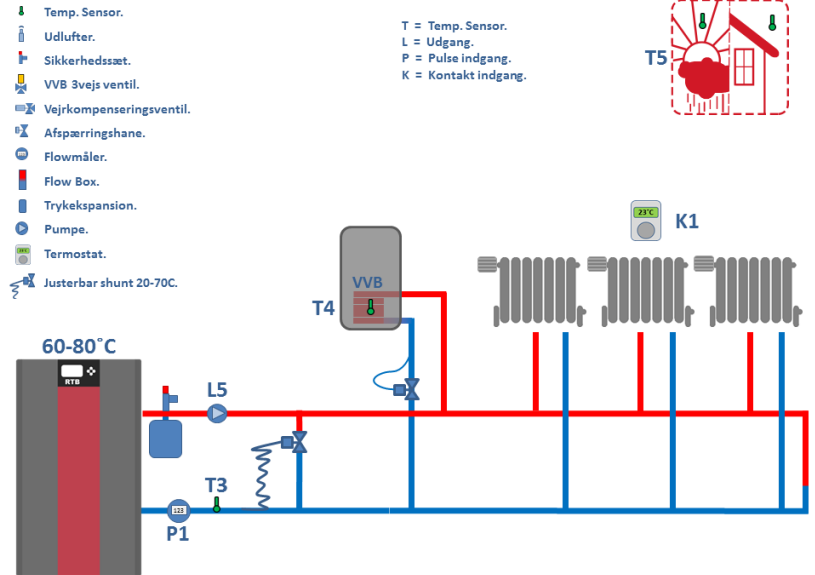

2. DHW w/ 2-way Hot Water Priority Valve

Typically used when DHW is small or when the surface coil is small.

Heat for the house is supplied while hot water is being produced

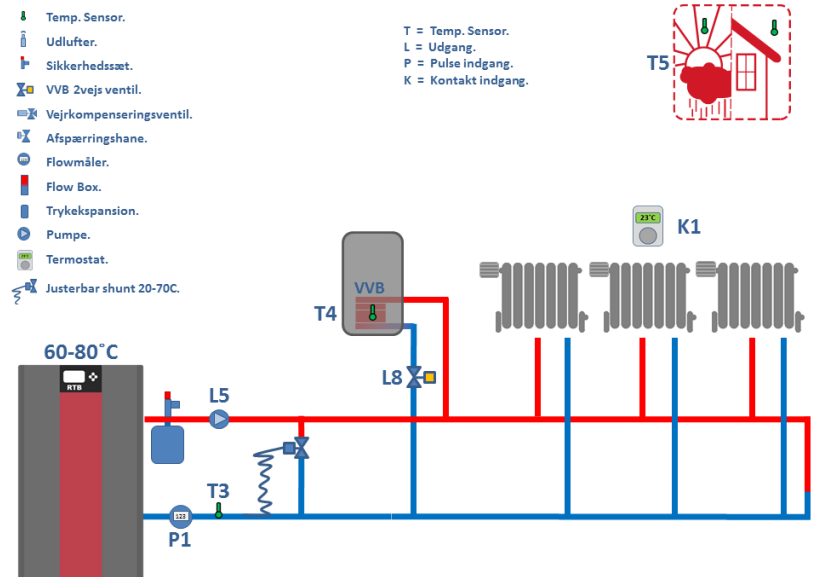

INSTALLATION DIAGRAMS:

A properly executed installation ensures that the system functions properly. Both national/local guidelines and requirements must always be observed. The boiler can be installed on a pressurized system up to max 2.5 bar.

3. DHW with 3-way valve

Typically used when the water heater is large, and when the surface coil is large.

The house is not supplied with heat while producing hot water. The house must therefore be able to manage without heat for short periods during the winter

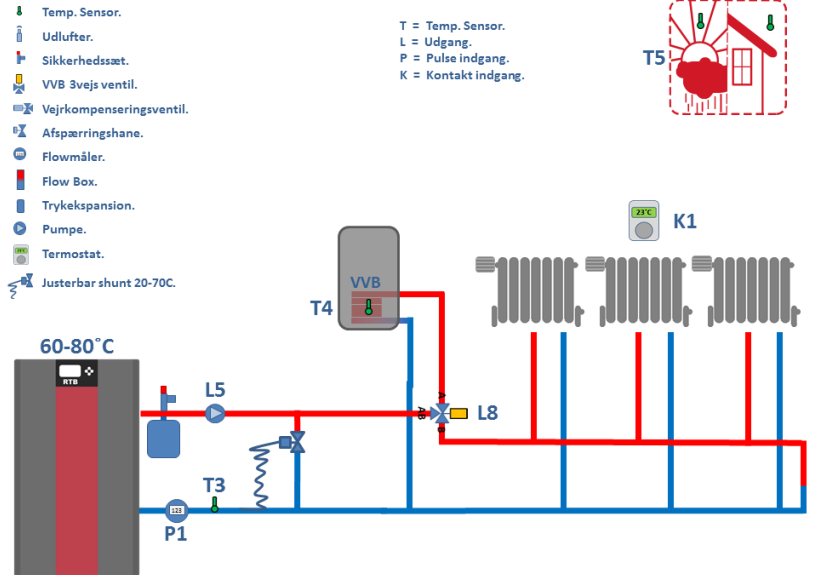

4. Weather Compensation and solar thermal heating for the DHW tank .

With an NBE flow box and 3-way weather compensation valve, the controller is able to control the minimum boiler return temperature on the system and adjust the forwarding temperature to the house based on an outdoor or indoor temperature reference.

Note ! This setup requires the use of an extension module to supply all the extra outputs required in the installation.

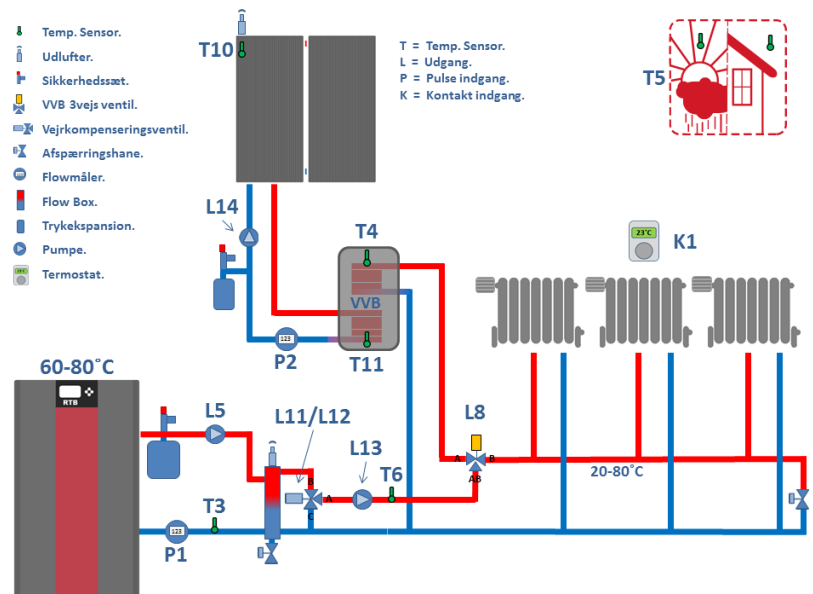

INSTALLATION DIAGRAMS:

A properly executed installation ensures that the system functions properly. Both national/local guidelines and requirements must always be observed. The boiler can be installed on a pressurized system up to max 2.5 bar.

5. NBE CASCADE

Bruges typisk, hvor varmebehovet er stort og svingende.

Der kan sættes op til 8 kedler sammen.

Kedlerne skal være online og registreret på www.stokercloud.dk

og derefter oprettes på

www.cascade.stokercloud.dk

Stoker cloud tænder og slukker kedlerne efter behov og sikrer en ens belastning af kedlerne.

- Temp. Sensor.
- Udlufter.
- Sikkerhedssæt.
- VVB 2vejs ventil.
- Vejrkompenseringsventil.
- Afspærringshane.
- Flowmåler.
- Flow Box.
- Trykexpansion.
- Pumpe.
- Termostat.

- T = Temp. Sensor.
- L = Udgang.
- P = Pulse indgang.
- K = Kontakt indgang.

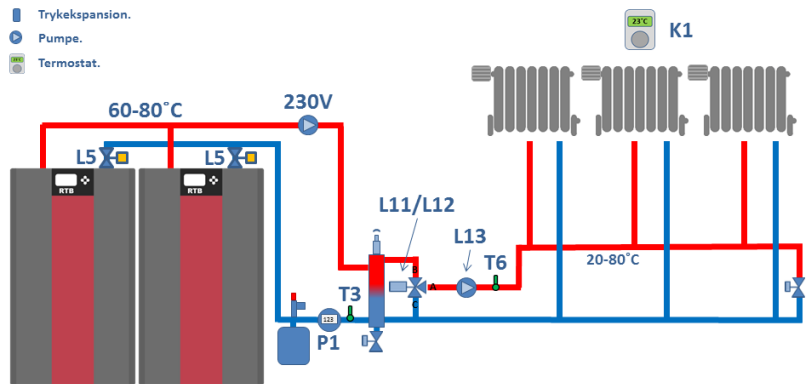

Sæby	
5.4 °C	Outdoor
19.2 °C	T5
44.2 °C	Zone 1
41 °C	Zone 1 wanted
34 %	Zone 1 valve

Power: 84.8kW (144 kW)
 Total consumption: 27922.4 kg
 External hopper content: -1,779.7 kg

rtb01	
151 °C	Chimney
65.5 °C	Boiler
77 %	Power
0 l/h	Flow
10.6 %	O2
8.3 %	O2 wanted
100.29 %	O2 low regulation
101.64 %	O2 mid regulation
105.24 %	O2 high regulation
98.1 %	Online uptime
30.6	Consumption index
1523.8 kg	Ash draw

rtb02	
158.5 °C	Chimney
70.7 °C	Boiler
100 %	Power
1572 l/h	Flow
5.7 %	O2
7.0 %	O2 wanted
105.19 %	O2 low regulation
105.44 %	O2 mid regulation
105.99 %	O2 high regulation
97.4 %	Online uptime
32.4	Consumption index
1362.9 kg	Ash draw

1
12-29-2015 09:00:06
Operation

rtb03	
45.9 °C	Chimney
64.1 °C	Boiler
0 %	Power
0 l/h	Flow
21.6 %	O2
20.9 %	O2 wanted
100.81 %	O2 low regulation
101.40 %	O2 mid regulation
100.22 %	O2 high regulation
95.0 %	Online uptime
32.3	Consumption index
874.2 kg	Ash draw

2
12-29-2015 09:00:27
Operation

rtb03	
45.9 °C	Chimney
64.1 °C	Boiler
0 %	Power
0 l/h	Flow
21.6 %	O2
20.9 %	O2 wanted
100.81 %	O2 low regulation
101.40 %	O2 mid regulation
100.22 %	O2 high regulation
95.0 %	Online uptime
32.3	Consumption index
874.2 kg	Ash draw

3
12-29-2015 09:00:17
STOP CASCADE
Stopped by cascade

INSTALLATION OF THE BOILER:

General Guidelines

1. The boiler should only be installed by qualified installers with a "Certificate for installation and service of small biofuel plant" and must be installed according to AT guidance on technical equipment – B.4.8 (only applicable in DK)
2. The boiler must **not** be installed on combustible_surfaces.
3. The chimney pipe over the boiler must be installed with a cleanout door and must be 500 mm in length above the boiler as to allow for easy dismantling of the controller cassette located at the back of the boiler. Install in a 90 degree chimney bend only if necessary. Uninsulated smoke pipes should be kept to a minimum. Angle the smoke pipe to 45 degree to minimize the accumulation of dust in the chimney pipe.
4. The chimney draft should be a minimum 5 PA and be stable. Overpressure must **not** occur. It is required to install a draft stabilizer. The draft stabilizer is mounted so that it draws heated air from the boiler room. This ensures a drying out of the chimney. Do not use a draft stabilizer, if a stove or wood boiler is mounted on the same chimney.
5. The boiler must be installed with an approved shunt.
NOTE: You may lose your warranty if failing to install an approved shunt with your system.

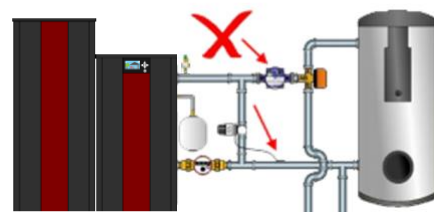
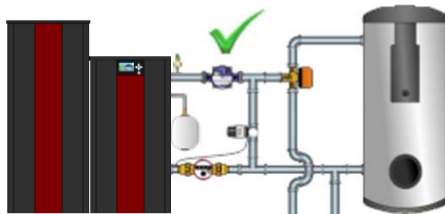
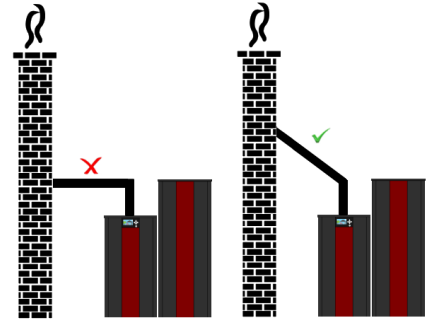

RTB PELLET HOPPERS:

RTB Hopper

	120	220	320	400
Width (Hopper)	300 mm	500 mm	700 mm	700 mm
Width (Boiler + Hopper)	806 mm	1006 mm	1206 mm	1506 mm
Height	1337 mm	1337 mm	1337 mm	1737 mm
Depth	854 mm	854 mm	854 mm	854 mm
Hopper Capacity*	120 kg	220 kg	320 kg	400 kg
Compatible w/ RTB:	10+16+30 kW	10+16+30 kW	10+16+30 kW	50 kW

*Results vary depending on the density of the pellets.

RTB Hopper w/ Vacuum Transport

	120 VAC	220 VAC	320 VAC	400 VAC
Width (Hopper)	300 mm	500 mm	700 mm	700 mm
Width (Boiler + Hopper)	806 mm	1006 mm	1206 mm	1506 mm
Height	1408 mm	1408 mm	1408 mm	1908 mm
Depth	854 mm	854 mm	854 mm	854 mm
Hopper Capacity*	120 kg	220 kg	320 kg	400 kg
Compatible w/ RTB	10+16+30 kW	10+16+30 kW	10+16+30 kW	50 kW

*Results vary depending on the density of the pellets.

RTB Twin Silo til kaskade

	250 Twin	500 Twin	220 Twin	320 Twin
Brede silo	1200 mm	1600 mm	500 mm	500 mm
Brede kedler + silo			1512 mm	2112 mm
Height	1000 mm	1000 mm	1337 mm	1737 mm
Depth	600 mm	800 mm	854 mm	854 mm
Hopper Capacity*	250 kg	500 kg	220 kg	320 kg
Compatible w/ RTB	10+16+30+50+80kW	10+16+30+50+80kW	10+16+30 kW	50 kW
Prepared for vacuum transport				

*Results vary depending on the density of the pellets.

BS+ PELLET HOPPERS:



BS+ Silo

	280	380
Width (hopper)	490 mm	750 mm
Width (boiler + hopper)	980 mm	1240 mm
Height	1220 mm	1220 mm
Depth	969 mm	969 mm
Hopper Capacity*	180 kg	250 kg
Passer til BS+	10+16+25 kW	10+16+25 kW

*Results vary depending on the density of the pellets.

Top ext. Not included as standard

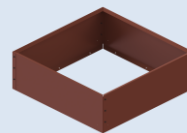
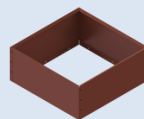
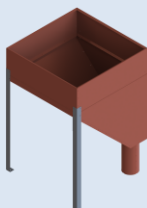
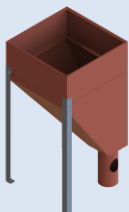

Std. Hopper

	60x60	80x80	60x60 ext	80x80 ext
Width	600 mm	800 mm	600 mm	800 mm
Height	1000 mm	1000 mm	250 mm	250 mm
Depth	600 mm	800mm	600 mm	600 mm
Hopper Capacity*	120 kg	150 kg	60 kg	100 kg
Compatible w/	all models	all models	60x60 silo	80x80 silo

*Results vary depending on the density of the pellets.

VACUUM TRANSPORT:

The vacuum system for wood pellets makes it easy to customize various delivery forms for your system. Here are a few examples of ways to configure your vacuum transport.

Large hopper, 3-5 ton with vacuum transport to RTB hopper.



Large hopper, 3-5 ton with vacuum transport to standard hopper.

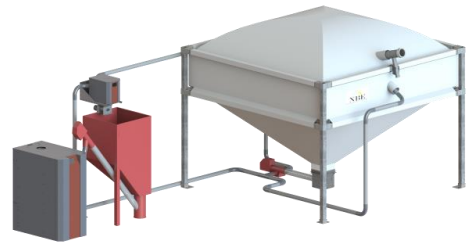

Homebuilt storage with vacuum transport to RTB hopper.

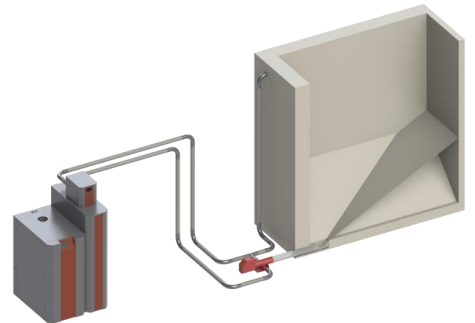

Home built storage with vacuum transport to standard hopper.

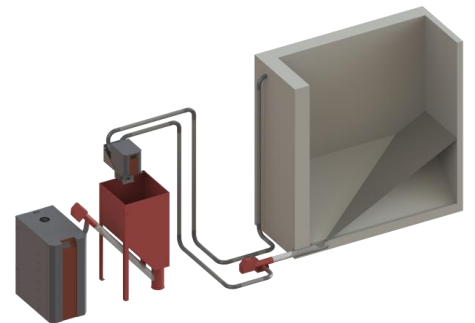

Wiring Diagram:

There may be factory-fitted wiring on outputs L5-L6 L7 L8 L9-L10-L11-L12-L13.

1. Quick Connector hose, Type: CEIN
2. Magnet Valve 1/2"
3. Y-splitter 8mm-1/2" CAN hose system
4. 12 pin motorprint board
5. Burner
6. Motor for internal auger
7. Rubber plug for igniter
8. Ceramic igniter, 250 W
9. 90 ° angle-CAN hose system
10. 8 mm compressor cleaning tube

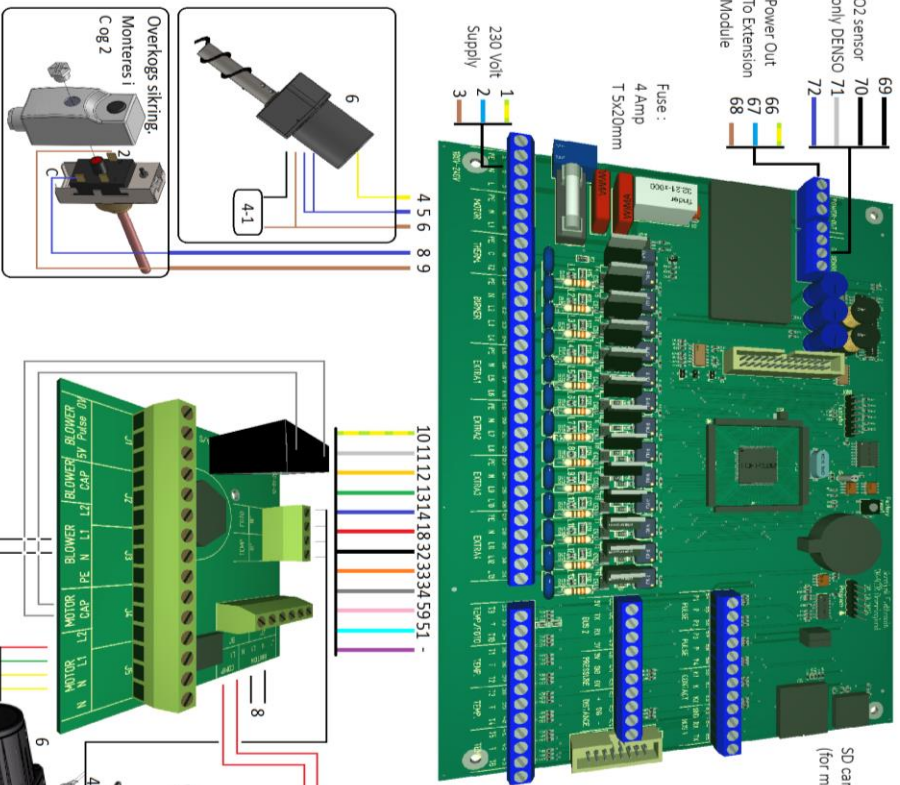

SD card slot
(for manual updating)

V13 Controller with 12 pin motorprint

- 10 PE (Ground) = Brown
- 11 N (Neutral) = White
- 6 L1 (External auger) = Brown
- 12 L2 (Blower) = Yellow
- 13 L3 (Internal Auger) = Green
- 14 L4 (Igniter) = Blue

- 17 L5 (RTB pump) = Purple/Brown
- 18 L6 (L1 Motorprint-compressor cleaning RTB) = Red
- 21 L7 (Ash auger RTB)
- 22 L8 (Extra)
- 25 L9 (Compressor Cleaning RTB)
- 26 L10 (Compressor Cleaning RTB)
- 29 L11
- 30 L12
- 31 L13
- 230 V. output for extra equipment
example:
Compressor cleaning, DHW priority
Pump, exhaust fan or alarm

- T (Shared)
- 35 T1 (Boiler temp)
- 37 T2 (Smoke temp sensor)
- 38 T3 (Boiler return temp sensor)
- 40 T4 (DHW priority)
- 41 T5 (External Temp Sensor)
- 43 T6 (Extra)
- 32 T9 (Burner temp. sensor)
- 34 T10 (Photo sensor)
- 52 Distance Sig (Distance sensor)
- 51 Distance + (supply)
- 53 Distance- (supply)
- 54 Puls P1 (Flowmeter)
- 56 Puls P2 (Extra)
- 57 Puls P3 (Extra)
- 59 Puls P4 (Blower RPM) = light red
- 61 Contact K (shared)
- 60 Contact K1 (External ON/OFF)
- 62 Contact K2 (Extra)
- Important, 0 Volt

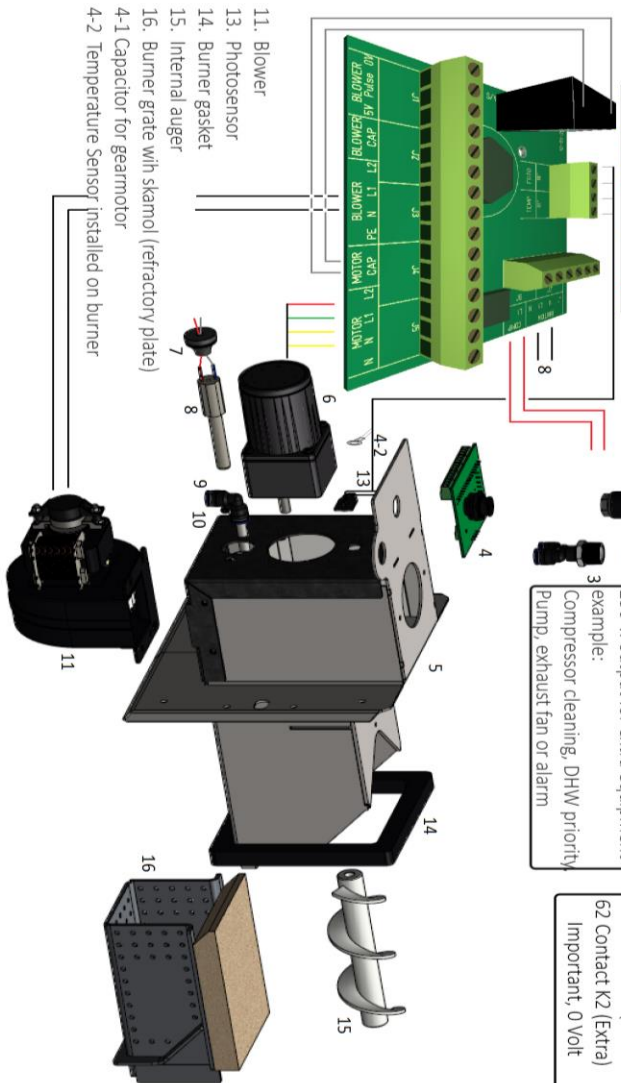

EXT. module

By adding more in and outputs, optional equipment can be added as:

- Vacuum transport.
- Compressor cleaning.
- O. controller.
- Hot water priority kit.
- Solar heating.
- Exhaust fan.
- Weather compensation.
- Distance sensor.
- And more.

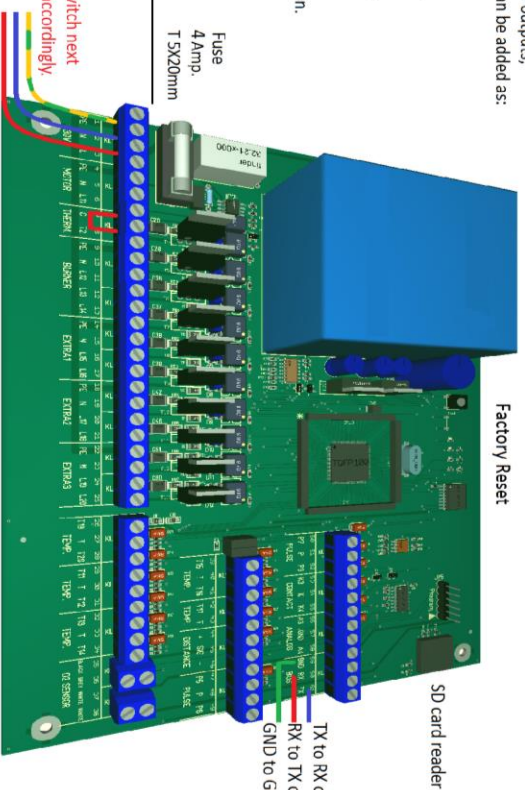

TX to RX on controller
 RX to TX on controller
 GND to GND on controller

Disconnect power supply to the controller.
 Place the ext. module next to the controller.
 Connect GND/RX/TX (Bus) to controller.
Notice RX/TX to be crossed.
 Connect optional equipment, if any.
 Connect module to power supply.

Turn on power to controller and ext. module.

In the controller go to menu 19, Extended setup.

Select the following:

Technical Setup = YES

Expansion module connected = YES

WIRING DIAGRAM

230 or 110 Volt.
Important: Set switch next to power supply accordingly

1. PE GND.
2. N. Power supply 230/110 Volt.
3. L. Power supply 230/110 Volt.

Output's:

4. PE GND.
5. N. Out.
6. L11. Out.
7. J Connected.
8. J Connected.
9. PE GND.
10. N. Out.
11. L12. Out.
12. L13. Out.
13. L14. Out.
14. PE GND.
15. N. Out.
16. L15. Out.
17. L16. Out.
18. PE GND.
19. N. Out.
20. L17. Out.
21. L18. Out.
22. PE GND.
23. N. Out.
24. L19. Out.
25. L20. Out.

Input's:

26. Temp. 19 input.
27. Temp. common.
28. Temp. 20 input.
29. Temp. 11 input.
30. Temp. common.
31. Temp. 12 input.
32. Temp. 13 input.
33. Temp. common.
34. Temp. 14 input.
35. Lambda sensor Black.
36. Lambda sensor Grey.
37. Lambda sensor White.
38. Lambda sensor White.
39. Temp. 15 input.
40. Temp. common.
41. Temp. 16 input.
42. Temp. 17 input.
43. Temp. common.
44. Distance.
45. Distance common.
46. Distance.

Input's:

Input's:

47. Pulse 5.
48. Pulse common.
49. Pulse 6.
50. Pulse 7.
51. Pulse common.
52. Pulse 8.
53. Contact 3.
54. Contact common.
55. Contact 4.
56. Analog 3.
57. Analog common.
58. Analog 4.
59. Bus GND. to Bus GND.
60. Bus RX. to TX.
61. Bus TX. to RX.

Communication to controller:

If the controller is connected to an expansion module, it will always read the oxygen level in the expansion module.

If the controller is not connected to an expansion module, it will read the oxygen level in the controller's input "O2"

If the controller is connected to an expansion module, it will read the distance sensor from either the controller input "DISTANCE" or from the expansion module's input "DISTANCE", depending on where the signal is strongest.

There are some lights in the expansion module:

Green light (Power) when the power is on.

Red light (ERROR) if there is no communication.

Yellow light (communication) if there is communication with a controller print.

Blue light (SD-card is being read) is on, while loading the program from the SD-card. When loading is complete, the blue light will switch off again.

CONNECTION DIAGRAM ELECTRICITY:

Overview of connectivity

	IN	OUT	FUNKTION
110-230	PE-N-L		110-230 Volt AC
SAFETY THERMOSTAT	L-L		Safety thermostat cutoff
MOTOR		PE-N-L1	External auger
BURNER		PE-N-L2	Fan
BURNER		PE-N-L3	Internal auger
BURNER		PE-N-L4	Ignition
EKSTRA 1		PE-N-L5	Circulation pump (can be set to other equipment)
EKSTRA 1		PE-N-L6	Compressor cleaning (can be set to other equipment)
EKSTRA 2		PE-N-L7	De-ashing auger
EKSTRA 2		PE-N-L8	Optional output for equipment
EKSTRA 3		PE-N-L9	Boiler Compressor Valve 1
EKSTRA 3		PE-N-L10	Boiler Compressor Valve 2
EKSTRA 4		PE-N-L11	Optional Output
EKSTRA 5		PE-N-L12	Optional Output
EKSTRA +		PE-N-L13	Optional Output
BUS	GRD, TX, RX,		Extension module
ILT	V1, V, V2		O2 control
CONTACT	K-K1		External ON/OFF
CONTACT	K-K2		FREE
PULS	P-P1		Flow meter system
PULS	P-P2		Flow meter solar heating
PULS	P-P3		FREE
PULS	P-P4		FAN RPM
DISTANCE	-, SIG, +		Distance sensor for hopper
LAN	RJ45		Internet connection
TEMP.	T- T1		Boiler temperature
TEMP.	T- T2		Smoke temperature
TEMP.	T- T3		Boiler return temperature
TEMP.	T- T4		DHW temperature
TEMP.	T- T5		External temperature
TEMP.	T- T6		FREE
TEMP.	T- T7		Compressor pressure sensor
EKS / FOTO	T- T9		Temperature sensor burner
EKS / FOTO	T-T10		Photo sensor burner

OPTIONAL EQUIPMENT:

The controller supports the following equipment. Aids in performing adjustments, cleaning, and knowledge.



INCLUDED WITH RTB
Smoke temp. sensor:
Reads the current smoke temperature in the display.



External temperature sensor:
Stops burner through an external temperature sensor.



Extension module:
Get additional 10 outputs for equipment. Prepared for O2 control.



Lambda sensor:
For the extension module.



Kit: oxygen control
Regulates the amount of oxygen in the flue gas. Regulates the quantity of wood pellet and air according to the desired O2 %.



Kit: flow meter
Read the system flow in the display and calculates the current power consumption for the house.



Hot Water Priority kit:
Produces hot water only when it is needed. Closes hot water tank, when the house is heated. Kits available with either 2 or 3 way motorized valve.



Distance sensor for hopper:
Sees how much is left in the hopper and displays it on the controller screen.



Kit: Compressor Cleaning System Small: Cleans the burner head efficiently with high pressure. With this kit you need to use your own compressor.



Exhaust fan:
Need greater chimney draft? The fan's RPM can be synched with the burner's power output. Can be connected to the burner controller.



INCLUDED WITH RTB
Kit: Compressor Cleaning Large: Clean the burner head efficiently with high pressure. With "low noise" compressor.



Kit: Weather compensating:
Maintains a high boiler temperature and adjusts the house inlet temperature in relation to the outdoor temperature.



Solar heating:
Use the pellet burner controller to run your solar system.



Wireless thermostat:
Stops the pellet burner with thermostat. Gives a smooth transition to summer time.

CONNECTING TO THE INTERNET:

To get your pellet boiler on Stokercloud, connect it to an external wireless router that is Internet connected. Before you get started make sure that you know the name (SSID) of your router, and the password to be used.

Connecting your burner via the web:

1. Open the wireless display and connect to your burner.
2. Select Setup> Connect to Stokercloud
3. Select the desired wireless router on the list and then enter the password for your router
4. You will get a confirmation from the app when the controller is successfully connected to the wireless router

Creating an account on Stokercloud

5. Go on www.stokercloud.dk and find your control in scroll down list, alternatively, enter the controller's serial number in the search box?
6. Log in using the controller's serial number and password number(found on a label on the controller board) and follow the instructions.
7. Enter the desired user name and password, and personal information.

Your pellet boiler is now online and you can always find it on www.stokercloud.dk by selecting your controller number in the scroll down list. Similarly, you can also connect to pellet boiler from the app even if your wireless display is not on the local network. Fx from the car or cottage.

Tip: Make sure that there is a solid blue light beside the SD card slot. A flashing light is an indication that your burner is not connected to the internet and you need to check your wireless router. If the lamp does not light up, your router is not connected to the internet. Check to see if your router is on and is functioning properly.

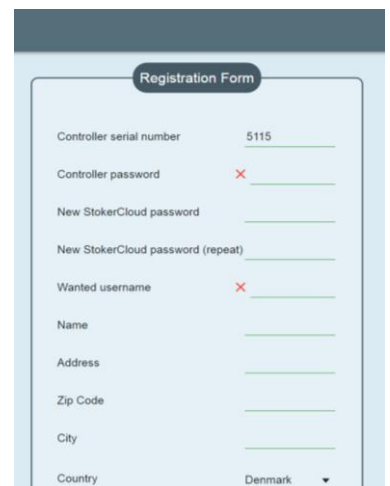
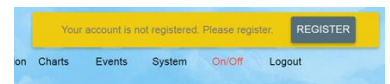

INTERNET CONNECTION:

6. Enter where you live.

This will be shown on www.stokercloud.dk,

If you do not want others to see the exact location of your system, simply move the drop pin a little.

Once your configuration are saved, you will now have your own webpage and system dashboard on Stokercloud.

After a short period of time you will see data streaming from the burner.

Do you want data on your mobile device?

Then download our App for the following devices:



Android Play, for android phone, search "StokerControl"



iTunes for iPhone mobile phone, search "StokerApp"



For Windows Mobile phone, search "StokerControl"

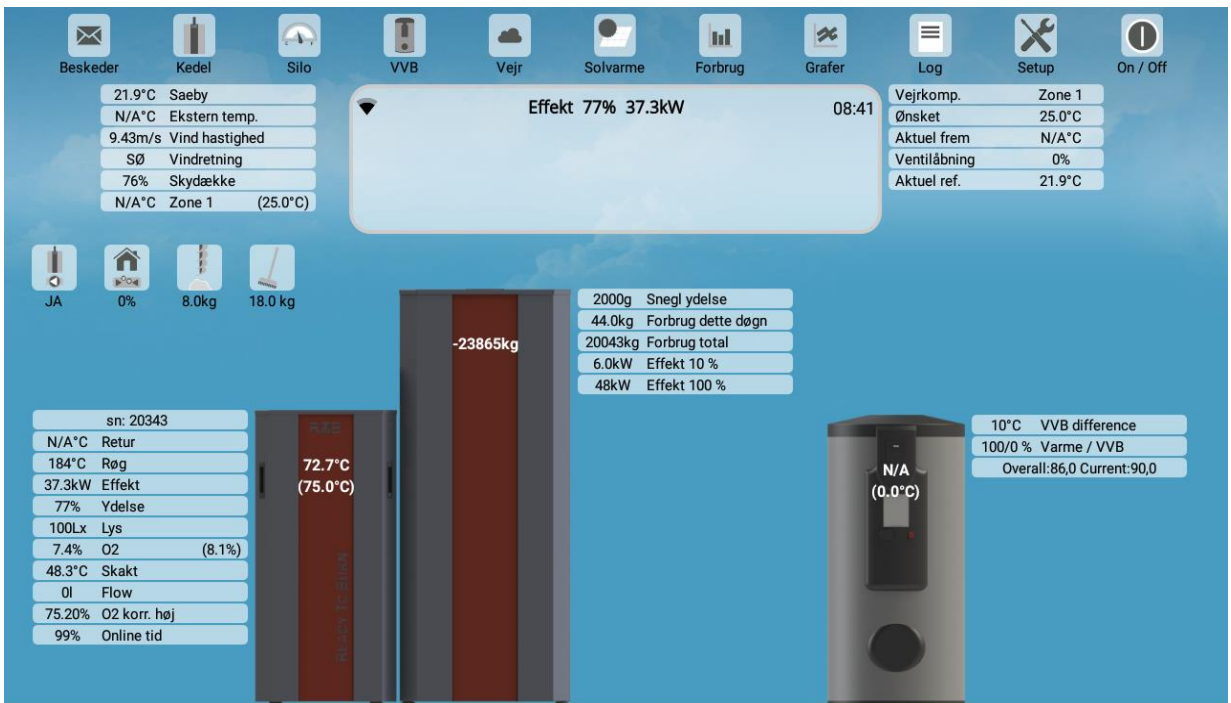
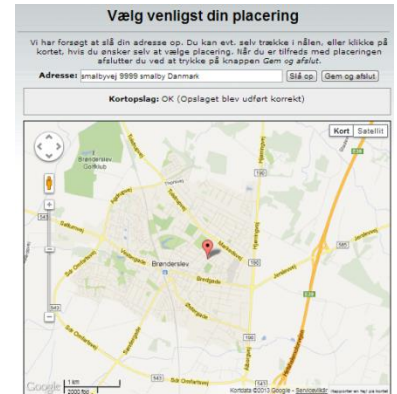

CLOUD SERVICE:

If your burner is registered online via our website www.stokercloud.dk, we can help keep an eye on your system. If something unexpected happens, such as too many ignitions, unstable operation, improper PI regulation etc., then we have the opportunity to help you ONLINE.

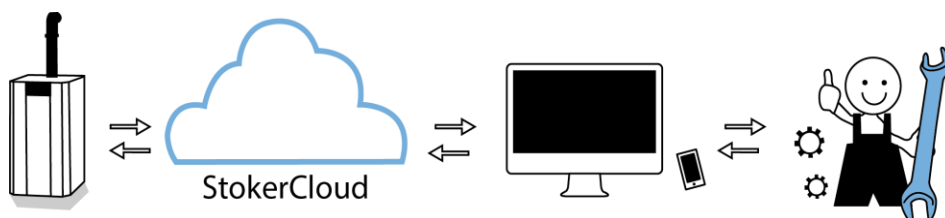

How it works:

- NBE observes abnormality on your graphs.
- If necessary, NBE will contact you by e-mail and ask your permission to make operational change.
- NBE evaluates your graphs and the patterns of your burner, and makes adjustments based on the observations.
- Changes to your settings can always be viewed via your system LOG.
- After adjusting, it should look like this

NBE's Cloud Service ensures:

- Fewest possible number of electric ignitions.
- Best possible PI regulation.
- An optimized system for your house.
- Lower wood pellet consumption.
- Security in your everyday life.
- The latest updates to the controller.

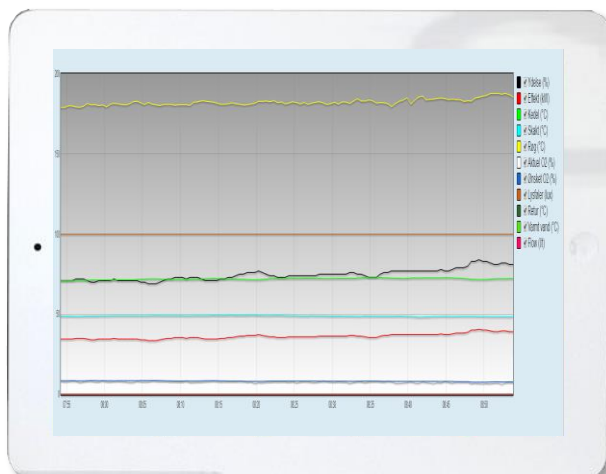
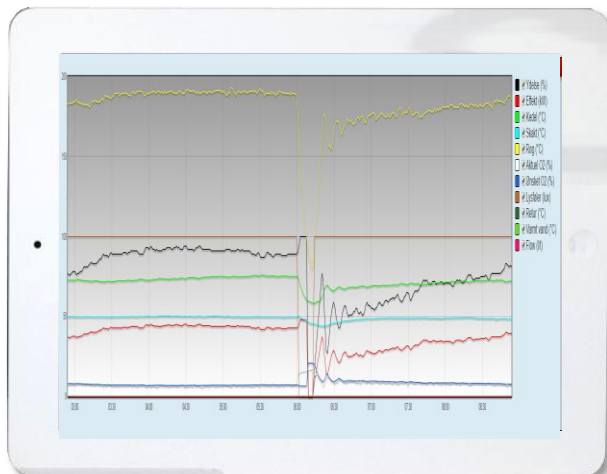

FIRST TIME START-UP:

Once the system is assembled, filled with water, connected with power, and supplied with pellets a few basic adjustments to the burner are required. This includes I. Calibrating the external auger by weighing the wood pellets and II. Adjusting the blower setting at 10 %, 50 % and 100 % power.

I. Weighing the pellets

1. Detach the drop hose from the drop tube on the burner and attach a plastic bag or similar underneath the drop hose.
2. Go to the System>Manual>External Auger> ON. This will force start the external auger. Allow for approximately 15 minutes of auger running time. This will ensure that the auger is completely filled and will allow for a more accurate weighing later. Once complete, discard the pellets from the plastic bag and refasten the empty plastic bag to the drop hose.
3. Go to the **Hopper** menu> **Force external auger>Force auger 6 min** to activate the 360 second test. Wood pellets will begin dispensing.



4. When the test is complete, remove the plastic bag, and weigh only the pellets on a kitchen scale. Enter the weight in the controller by going to the **Hopper** menu >**Auger capacity/6min**> enter “pellet weight”.

II Adjusting the blower

1. Turn on the system by pressing the **ON/OFF** button on the tablet.
2. Go to the **Boiler** menu>Regulation menu > set **Min** power = 100 % and **Max Power** = 100 %. This will lock output to 100 % power. Allow for 15 minutes for the burner to reach 100 % output. (*Note: when locking output to 50 % power, set Min & Max power = 50 %. Similarly, when locking output at 10 %, set Min & Max power = 10 %.*)
3. Take a measurement of either the CO₂ % or O₂ % in the chimney using a flue gas analyzer (or if O₂ control is available on your system set O₂ Control method to SHOW ONLY) and control that the CO₂ % or O₂ % at 100 % power are within range to the values shown in the table below.

Burner Type	CO ₂ % / O ₂ % @ 10% power	CO ₂ % / O ₂ % @ 50% power	CO ₂ % / O ₂ % @ 100% power
RTB10 / BS+ 10	4 / 17	10 / 11	13 / 8
RTB16 / BS+ 16	4 / 17	10 / 11	13 / 8
RTB30 / BS+ 25	4 / 17	10 / 11	13 / 8
RTB50	5 / 16	11 / 10	14 / 7
RTB80	6 / 15	11 / 10	14 / 7

If the O₂ % reading is too low, (or similarly if the CO₂ % is too high) compared to the values on the table, then increase the blower speed to increase the O₂ % and decrease the CO₂ % in the combustion. Similarly, to decrease the O₂ % and increase the CO₂ %, decrease the blower speed.

To adjust the blower speed, go to the **Boiler** >**Fan** menu>**Speed at 100 % power** and adjust the blower speed by a few % at a time. Allow for a few minutes for the adjustment to take effect. Take an O₂ % or CO₂ % reading and confirm that the values taken are within range to the values shown in the table (*Note: fan speed at 50 % and 10 % power can also be found under the Fan menu*).

4. Repeat steps 1-3 to adjust the blower speed at 50 % and 10 % power.
5. After adjusting the blower at 100 %, 50 % and 10 %, go to the **Regulation** Menu and set **min power** = 10 % and **max power** = 100 %. Begin normal operation.

Note: Be aware that because of the dosages of the auger, the CO₂ reading of a CO₂ measurement will never be 100 % stable.

SERVICE MAINTENANCE

Cleaning should be carried out as needed.

There is a big difference depending on the construction setup, adjustments and wood pellet quality on how often maintenance should be performed.

The maintenance table is only indicative and applies only for RTB systems!

When needed	7 days	14 days	30 days	1/2 annually	1 annually	RTB X BS+ X
X X				X X	X X	Cleaning cinders out of burner head.
				X X	X X	Cleaning under the combustion grate for dust and cinders.
					X X	Cleaning photo sensor from soot and dust.
					X X	Cleaning burner fan from dust.
X			X	X	X	Cleaning / controlling boiler / smoke pipe
					X	Empty compressor for condensation
X X			X	X		Empty the ash pan, typically after 1.000-2.000 kg pellets.
					X X	Check gaskets / replace worn gaskets.
X X				X X	(X X O2)	Adjusting the burner (weighing the pellets).
X X	X X	X X				Filling the hopper.
					X X	Adjusting the burner (Co2 measurement)
					X X	Chimney sweeper.

Turn off the burner in connection with cleaning.

Turn off the controller and allow to cool for approx. 5 min. Once the burner is completely turned off, it is ready for cleaning. Unplug the burner, remove the shield, drop shaft and remove the burner from the boiler so work can be easily performed.

The ash pan.

The ash pan is to be emptied for ash, which can easily be used as fertilizer.

! Never throw warm ashes in the trash bin, but let it cool off in a metal bucket. Warm ashes can burn if it gets air (O2)

! Remember to mount the ash bin correctly after emptying it, otherwise smoke can leak out the back!

Burner head.

Remove any ash or cinders from the grate. Remove any pellet remnants under the burner grate.

Wipe the photo sensor clean.

Ensure that there is nothing lodged in the fan and that it can rotate freely.

Hopper.

Since pellets naturally contain dust, you should once in a while empty the hopper completely. The more dust that is present in the hopper, the less the auger will dispense, and the more unstable the dosing. The boiler will go out of adjustment with greater risk of downtime. How often one should empty the hopper depends greatly on the design and quality of the pellets you use.

Start-Up after cleaning.

Reassemble the system and turn on the controller, the burner will start up automatically.

TROUBLESHOOTING:

We have collected the most typical solutions to small problems.

Problem.	Possible cause.	Possible solution.
Alarm hot drop shaft.	Cinders in the burner head. Back pressure in the boiler. No draft in the chimney.	More air for combustion. Clean the boiler etc. Increase the chimney height. Clean the burner head regularly. Switch to a better quality of pellets.
Smoke in the hopper.	Ash in the hopper.	Clean the boiler etc.
Smoke setbacks	No draft in the chimney. Drop shaft sensor defective. Unfortunate wind conditions.	Insulate the smoke pipe. Increase the chimney height. Submerge a liner in the chimney. Increase temperature of the smoke, remove the semi cleaning grates from the boiler. Change temperature sensor on the burner print. Increase the chimney height. Close doors etc. Make intake on the same side as the chimney.
Alarm ignition	Defective ignition. Ignition is located wrong. Burner grate is fitted wrong. Too high chimney draft.	Replace the electrical igniter with a new one. Mount it correctly Mount it correctly. Install a draft stabilizer in the chimney. Set electric ignition power up. Reduce the fan speed during ignition.
Alarm temp. boiler	Stopped fan Defective temperature sensor Temperature sensor fallen off the boiler. Power too low compared to the house.	Check if the fan can run, replace if necessary Change temperature sensor. Mount it correctly, attach the sensor with a cable tie. Make a new adjustment of the burner. Adjust the alarm limit down. Add more power to the burner if possible.
Alarm motor output	Fault current on the electric grid Relay defective	Supply the burner from another protection group. Send the controller in for repair.
Alarm no fuel	Hopper is empty Flame has gone in operation Photo sensor is defective	Fill hopper with wood pellets and restart. Make a new adjustment of burner. Change photo sensor with a new one.
Plug is disconnected	Unstable fuel supply Burner plug is not fitted Dirt inside the plug to burner No connection to the burner	Empty auger / hopper for sawdust. Insert the plug of the burner Clean the plug for pellet dust. Change temperature sensor on the burner print.

TROUBLESHOOTING:

Problem.	Possible cause.	Possible solution.
Alarm RPM	RPM sensor defective.	Change the fan. Change to % regulation at the fan.
No power to the controller	Defective fuse in the controller. Safety thermostat not active. The controller has been overvoltage.	Replace the fuse to a new one. Reconnect by firmly pressing the red button. Send controller to NBE for repair.
The burner deactivate residual current protection	Electric ignition is faulty. Current leak in a component. Cables exposed.	Change the electric ignition to a new. Note when RCD deactivate, replace the component. Check cables, insulate them if possible.
Too high pellet consumption	Lean burning. Too high chimney draft. Uninsulated pipes in the installation.	Make a new adjustment of the burner. Install draft stabilizer in the chimney. Insulate with pipe insulation.
Too many electric ignitions	Flow in the system is fluctuating. External thermostat unstable.	Set the pressure controlled circulation pump to fixed pressure. Set "External wait" up in the controller.
Unburnt pellets in the ash	Lean burning. The grate is placed incorrectly. Too many pellets on the grate. The fan is adjusted too high. Too high chimney draft.	Make a new adjustment of the burner. Mount it correctly. Make a new adjustment of the burner. Make a new adjustment of the burner. Install a draft stabilizer in the chimney.
Cinders on the grate	Blower cleaning is not sufficient. Poor quality pellets.	Adjust the fan % up to clean, and the time between the down. Clean the grate mechanical more frequently. Change supplier. Mount compressor cleaning.
The boiler condensates	Too low chimney temperature.	Change the grate to a model that is more open. Adjust the fan up at 10, 50 and 100 % power. Adjust the burner power down in "auto calculation". See page 27 about flue gas condensation.

PREVENTING FLUE GAS CONDENSATION:

When a boiler has an extremely high efficiency >93 %, the temperature of the flue gas is naturally low. Typical flue loss is only 2-3 %. This creates greater demands on your chimney and on how to adapt the boiler to its existing installation. It is important, if you have condensation to prevent it; otherwise you risk developing soot into the chimney and corrosion in the boiler.

Note: Even if there is water in the boiler, it may be due to condensation from the chimney.

Things that can prevent condensation in the boiler and chimney.

- 1. High chimney > 5m.**
Provides a good draft in all conditions.
- 2. Small cleaning in the chimney 125mm – 150mm.**
Provides better flow, and can "carry" out more moisture.
- 3. Short un-insulated smoke pipe < 0,5m.**
Do not cool down the smoke unnecessarily before it reaches the chimney.
- 4. Draft stabilizer.**
Stabilizes the draft, and provides the chimney with dry air.
- 5. High boiler temperature >70C degrees .**
10 degrees up in the boiler temperature gives 10 degrees more smoke temperature.
- 6. Suitable return temperature > 55C degrees.**
The boiler may condense when the heat exchanger surfaces are below 47 degrees.
- 7. Heated boiler room.**
Lowers cooling of the boiler and smoke pipe and provides draft stabilizer more hot air to work with.
- 8. More oxygen in combustion.**
Increases air flow in the boiler, and carries more moisture, 1 % more oxygen costs approx. 0,5 % in efficiency.
- 9. Remove the turbulators.**
Decreases resistance of the boiler, and get a bad chimney to work better. The gas temperature typically increases to approx. 100 degrees. The burner should be readjusted after the turbulators are removed.
- 10. Keep the boiler heated at all times.**
If you are using DHW priority in the controller, and the boiler starts being cold by every start, the boiler does not manage to dry out at every start.
- 11. Mount exhaust fan to chimney.**
Helps the flow the right way, from CHIP 6.82 can exhaust fan be connected directly to the controller..

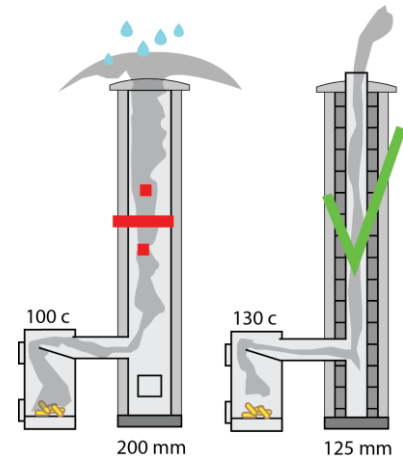

TABLET MENU STRUCTURE:

Controller version V13 with tablet.

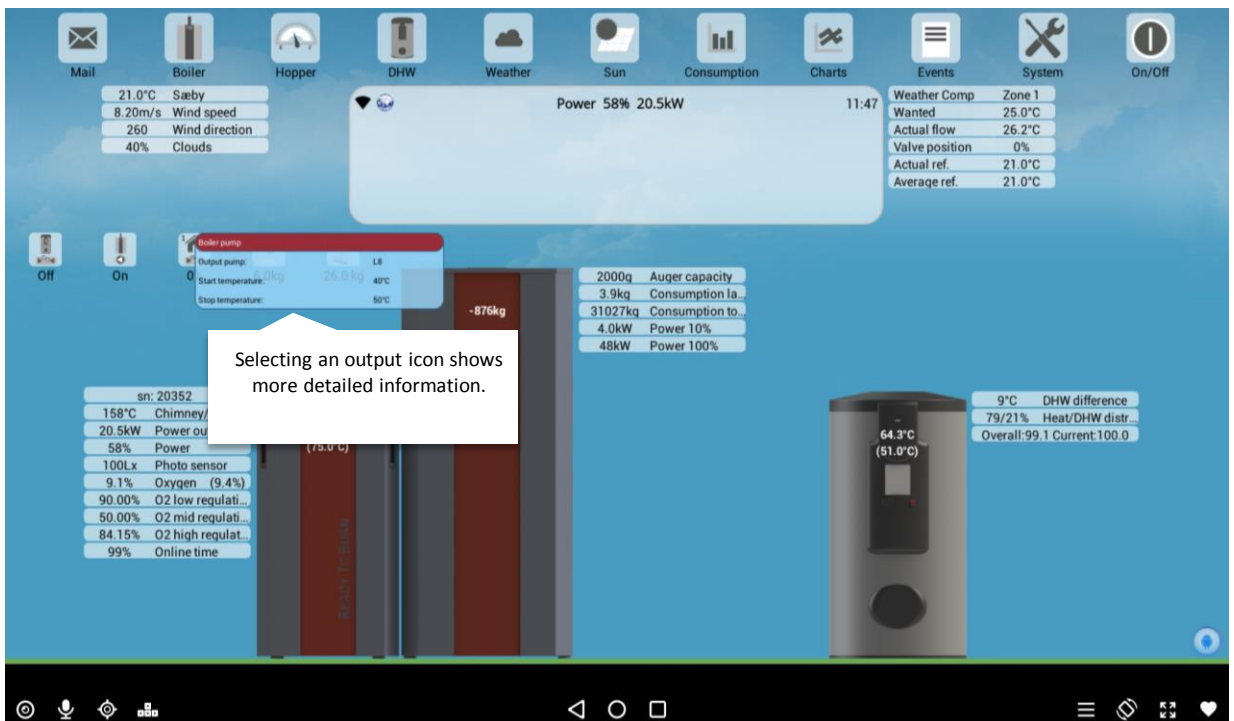
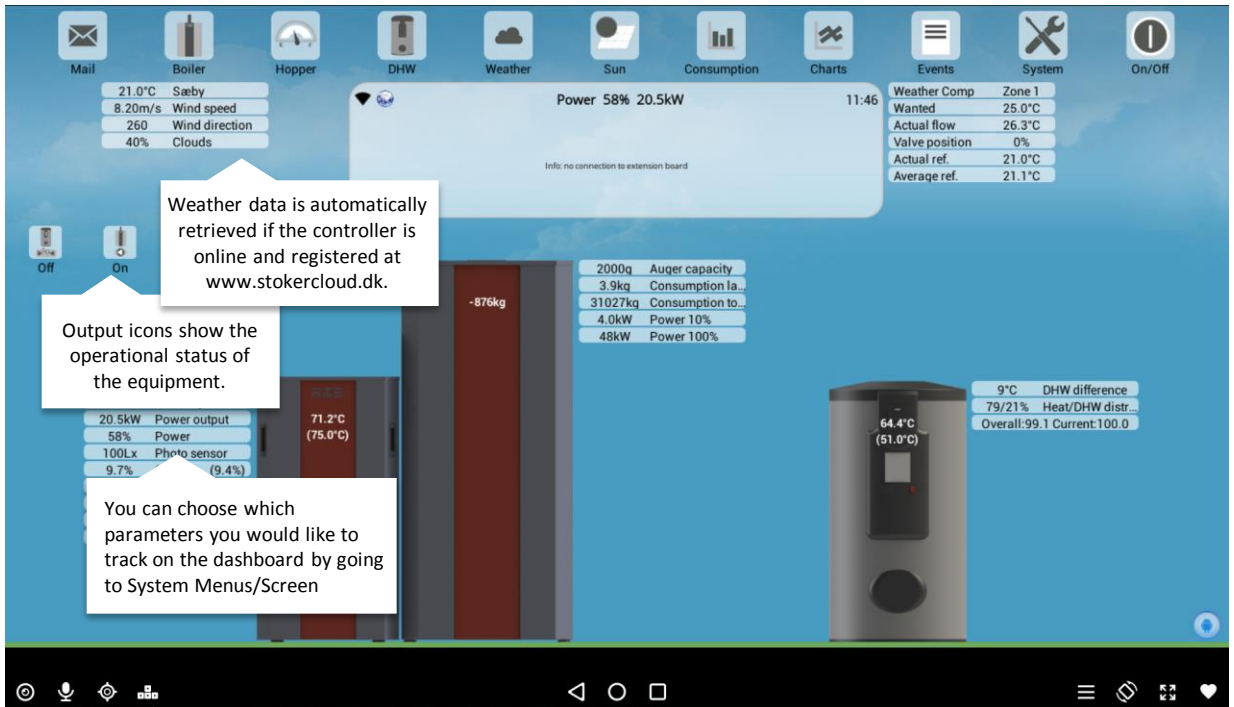

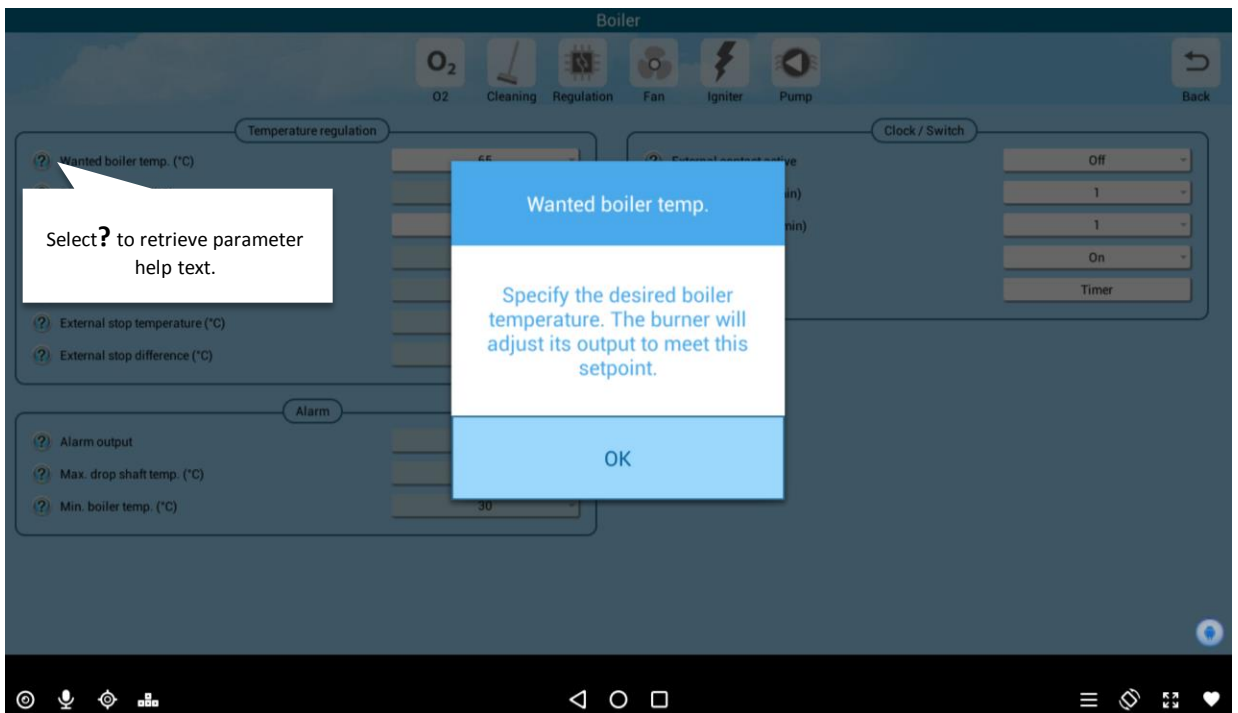
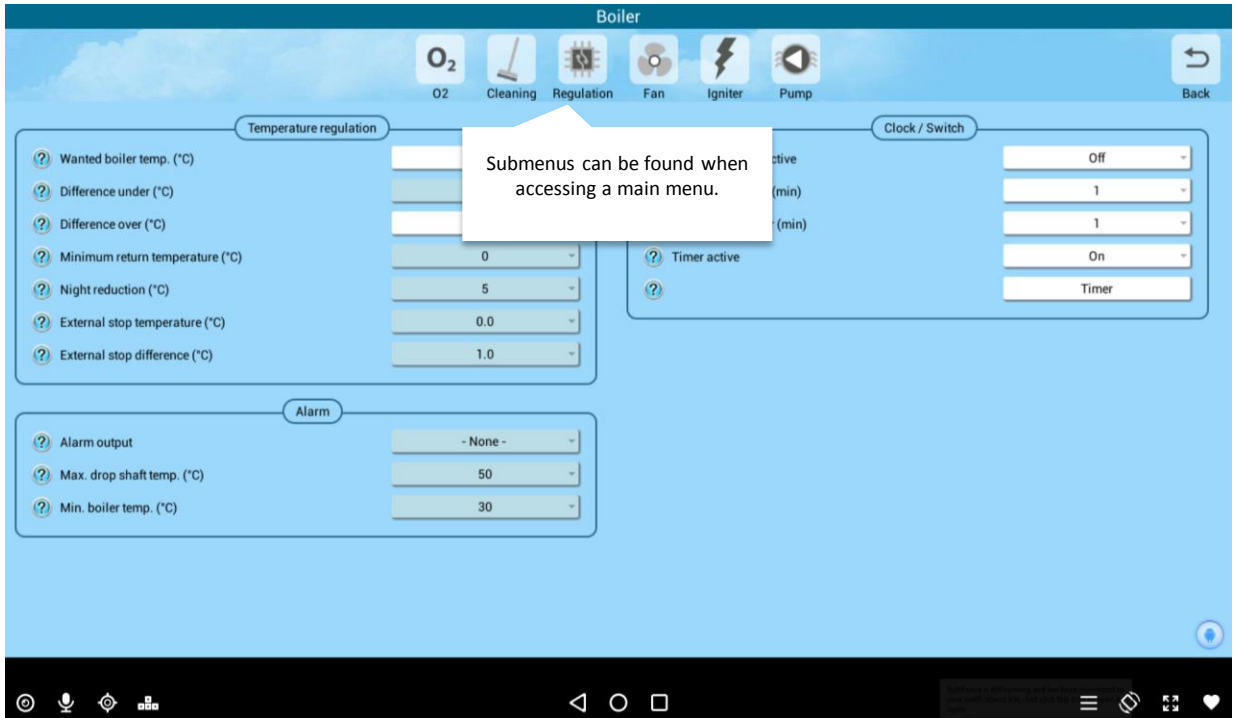

Timer

Save
All on
All off
Clear
Back

	Mon	Tue	Wed	Thu	Fri	Sat	Sun
00.00 - 02.00	5	5	5	5	5	5	5
02.00 - 04.00	5	5	5	5	5	5	5
04.00 - 06.00	off	off	off	off	off	off	off
06.00 - 08.00	on	on	on	on	on	on	on
08.00 - 10.00	on	on	on	on	on	on	on
10.00 - 12.00	on	on	on	on	on	on	on
12.00 - 14.00	on	on	on	on	on	on	on
14.00 - 16.00	on	on	on	on	on	on	on
16.00 - 18.00	on	on	on	on	on	on	on
18.00 - 20.00	on	on	on	on	on	on	on
20.00 - 22.00	on	on	on	on	on	on	on
22.00 - 24.00	on	on	on	on	on	on	on

Under boiler timer you can choose between ON, OFF, or nighttime reduction temperature.

Urstyring tider

Tilbage
Hjælp

	Man	Tir	Ons	Tor	Fre	Lør	Søn
00.00 - 02.00	off	off	off	off	off	off	off
02.00 - 04.00	off	off	off	off	off	off	off
04.00 - 06.00	on	on	on	on	on	on	on
06.00 - 08.00	on	on	on	on	on	on	on
08.00 - 10.00	on	on	on	on	on	on	on
10.00 - 12.00	on	on	on	on	on	on	on
12.00 - 14.00	on	on	on	on	on	on	on

Under the DHW time you can choose between On/Off during a timer period.

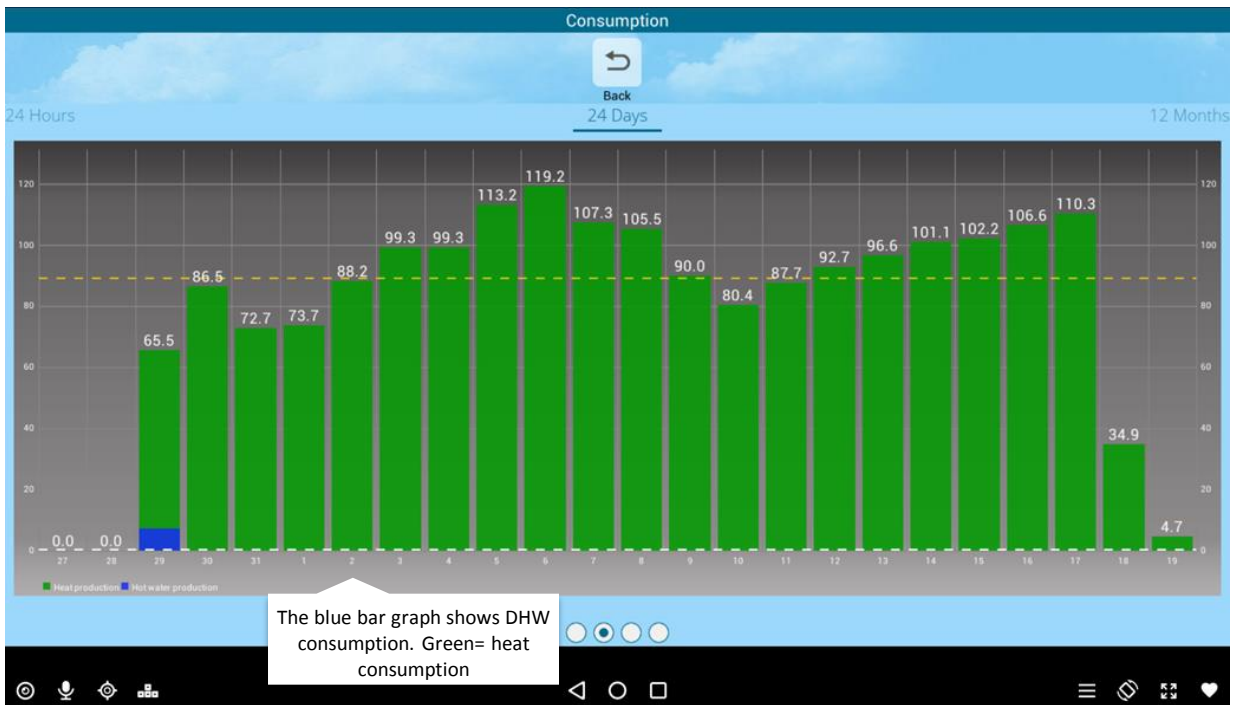
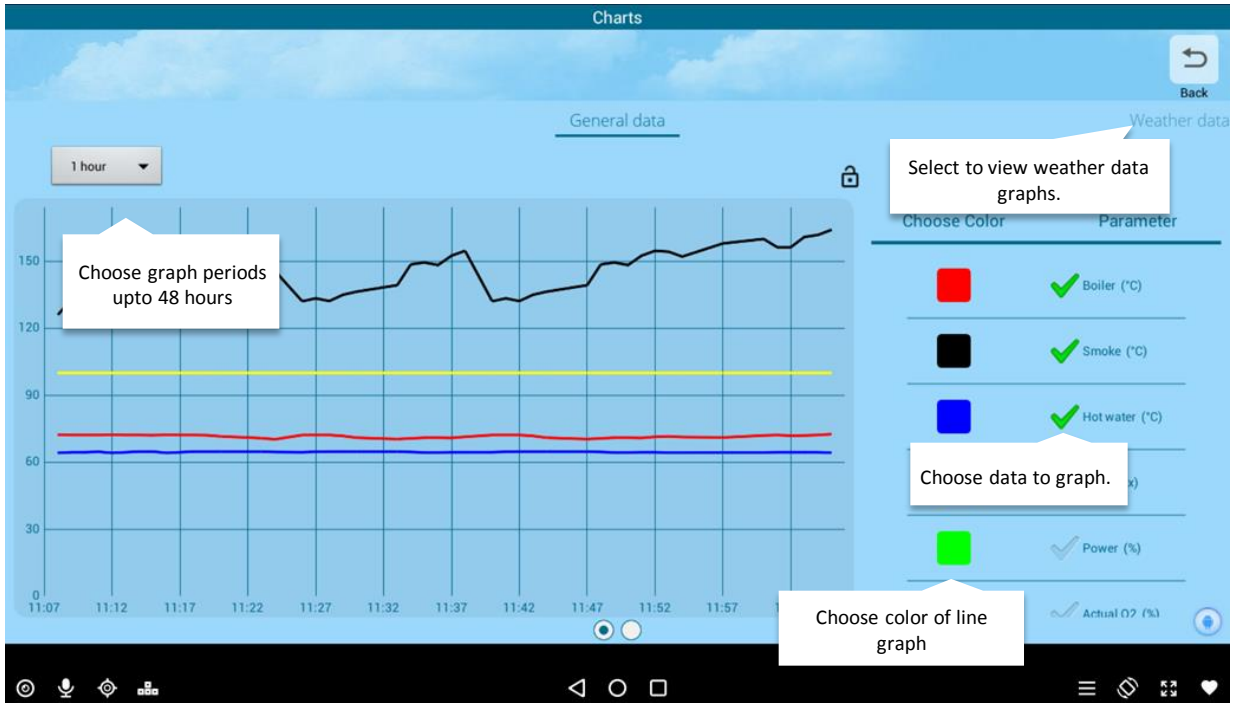

Sun

Temperature

- Wanted sunpanel temperature (°C)
- Pumpstart temperature difference (°C)
- Pumpstop temperature difference (°C)
- Pump minimum speed (%)
- DHW maximum temperature (°C)
- Flow liter/pulse (l/p)
- Excess to top

Input/output

- Output sun pump
- Output sun excess heat
- Sun panel 1 temp. sensor
- Sun panel 2 temp. sensor
- Input DHW bottom temperature
- Input excess heat temperature

Mail
21.0°C Sæby
8.20m/s Wind speed
260 Wind direction
40% Clouds

Boiler
19.1kW Power output
54% Power
100Lx Photo sensor
9.7% Oxygen (9.7%)
90.00% O2 low regulati...
50.00% O2 mid regulati...
84.15% O2 high regulat...
99% Online time

Hopper
5.8kg
25.8 kg

DHW
-877kg
2000g Auger capacity
4.1kg Consumption la...
31027kg Consumption to...
4.0kW Power 10%
48kW Power 100%

Weather
Power 54% 19.1kW
11:51

Sun

Consumption

Charts

Events
Weather Comp Zone 1
Wanted 25.0°C
Actual flow 26.0°C
Valve position 0%
Actual ref. 21.0°C
Average ref. 21.0°C

System
9°C DHW difference
79/21% Heat/DHW distr...
Overall:99.0 Current:100.0

On/Off

LOG

Log

Tilbage

lørdag 30-01-16

	10:33 lørdag Udgang solvarme pumpe	0->1
	Displays setting changes	100->70
	10:01 lørdag minimum 0% indhold	250->0
	09:58 lørdag VVB -> Drift	
	Displays changes in operations status	
	09:24 lørdag Aske rens	
	Provides info messages .	
	09:24 lørdag Drift -> VVB	

Manuel

Tilbage

Udgang L1 Ekstern snegl ✓

Udgang L2 Blæser ✓

Udgang L6

Udgang L7

Udgang L8 Udgang pumpe

Udgang L9 Udgang kedel ventil 1 ✓

Udgang L10 Udgang kedel ventil 2

Denne funktion bør benyttes med største forsigtighed. Alle udgange stoppes og kan derefter aktiveres manuelt, bør aldrig benyttes, hvis fyret er i drift!

Fortryd Ok

Manual control of outputs is used to test the functioning of equipment.

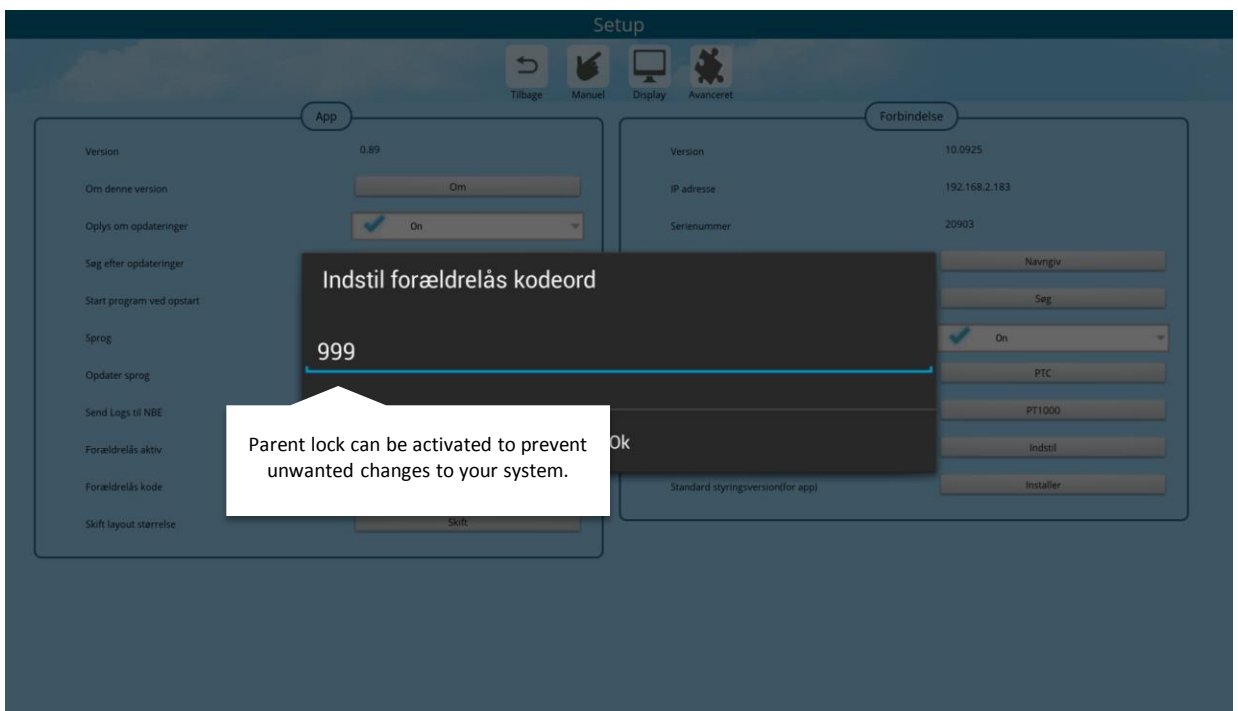
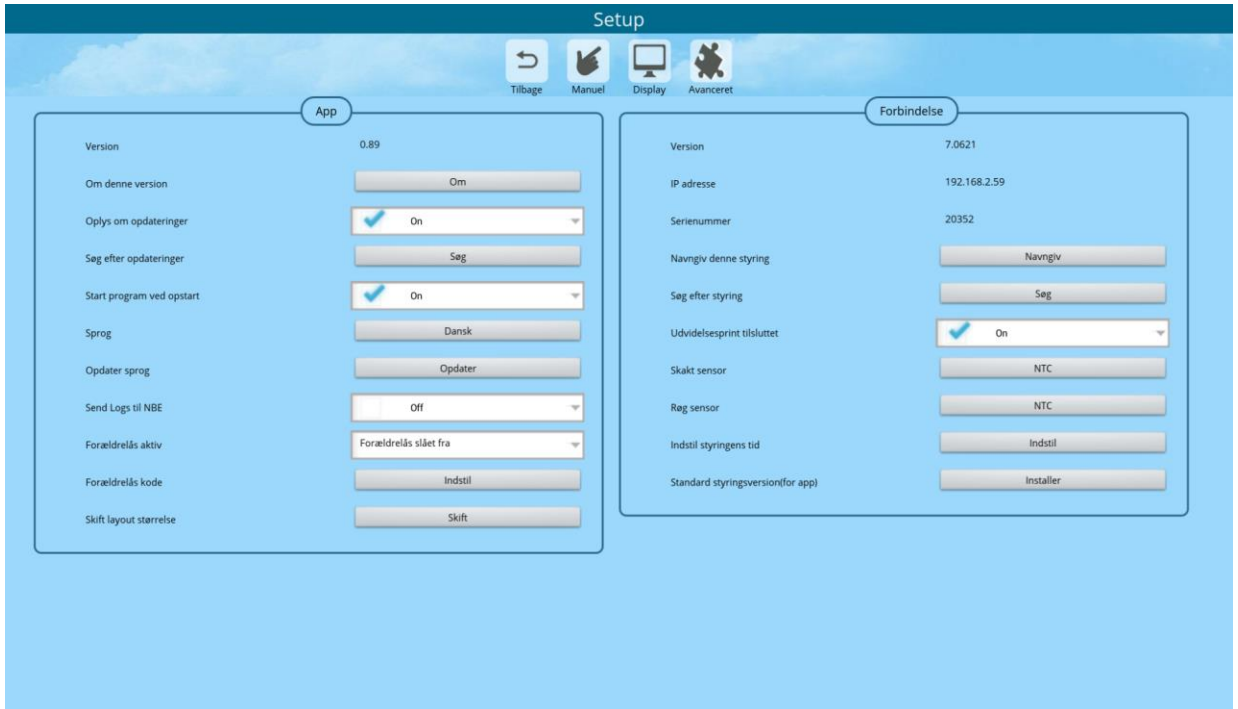

WARRANTY

All products purchased from NBE is covered by the current Danish Purchasing Law. This includes 6 months warranty on the products valid from the date of receipt. A 2 year warranty is granted with the completion of the Warranty Registration.

If you purchase your RTB from an authorized dealer, and have your boiler online as well as have annual service visits, the guarantee can be increased to 36 months on the technique and up till 10 years on the boiler vessel.

The customers installs it himself	6 months
A plumber installs the boiler (not authorized dealer).	6 months
An authorized dealer installs the boiler + Online on StokerCloud.	12 months
An authorized dealer installs the boiler + Online on StokerCloud + annual service visits	36 months
An authorized dealer installs the boiler + online on StokerCloud + annual service visits.	10 years*

* Corrosion warranty on the boiler vessel.

The warranty covers only manufacturing and material defects.

The warranty of product failure of the system when under warranty, NBE will repair the spare part at no charge to the buyer. Buyer will be responsible for the installation or replacement of the part. If NBE offers repair of the defective part, the purchaser shall send the part to NBE for repair. NBE will return the part once repaired.

Guarantee shall be invalid if product failure is due to circumstances caused by the buyer; either by accident and/or abuse of the product, inadequate cleaning, chimney conditions, as well as circumstances where NBE has no influence. In addition, the warranty is invalid due to misuse of the burner – e.g. using fuel that is not approved by NBE.

The warranty does not cover parts such as the electrical igniter.

The buyer is obligated to check the goods immediately upon receipt.

If the buyer declares that the delivery was inadequate or defective, the customer must immediately and without delay make a written claim with NBE.

Returns are only made by agreement with NBE.

To the extent that NBE is liable to the purchaser, NBE's liability is limited only to direct loss and not to damages incurred by connected equipment and / or indirect damage, loss of earnings, operating losses, connection costs, etc.

Responsibilities:

NBE assumes no responsibility as a result of the purchaser's legal relations with third parties. All orders are accepted subject to force majeure, including war, civil unrest, natural disasters, strikes and lockouts, failing supplies of raw materials, fire, damage of NBE or its supplier network, lack of transport opportunities, import/export prohibitions or any other event which prevents or restricts NBE's ability to deliver.

NBE has in cases of force majeure, the right to cancel the transaction or any part thereof, or to deliver the agreed product as soon as the obstacle to normal delivery has lapsed. In cases of force majeure, NBE will not be held responsible for any losses incurred by the purchaser due to changes, sold out items or changes to specifications in the product manual.

It is the buyer's responsibility to register the equipment to the appropriate authorities. If any disputes arise between the authorities and the purchaser, NBE will be held harmless from any claims or disputes.

The following can be delivered upon request:

- Exception of the expansion by Labor Inspectorate.
- Chimneys endorsements.
- Approval of Technology Institute (DTI).
- Print charts.

The material is also available on www.nbe-global.com.



EC DECLARATION OF CONFORMITY

No. : 0112-2016

The undersigned, representing the following manufacturer

Manufacturer : NBE production A/S

Address : Kjeldgaardvej 2, DK9300 Saeby, Denmark
--

or representing the manufacturer's authorized representative established within the Community (or the EEA) indicated hereafter

Authorized representative :

address :

herewith declares that the product

Product identification :

Pellets Systems:

BS+ 10, BS+ 16, BS+ 25

RTB 10, RTB 10 VAC,

RTB 16, RTB 16 VAC,

RTB 30, RTB 30 VAC,

RTB 50, RTB 50 VAC,

RTB 80.

is in conformity with the provisions of the following EC directive(s)
(including all applicable amendments)

Reference n °	Title
<i>EN 303-5:2012</i>	<i>Europe Norm</i>
<i>2006/95-EC</i>	<i>Low Voltage Directive</i>
<i>2004/08-EC</i>	<i>EMC directive (EMCD)</i>
<i>97/23/EEC</i>	<i>Pressure Equipment Directive</i>
<i>2006/42-EC</i>	<i>Machinery directive</i>
<i>Arbejdstilsynets bekendtgørelse</i>	<i>Nr. 612</i>

and that the standards and/or technical specifications referenced overleaf have been applied.

Last two digits of the year in which the CE marking was affixed: ...14

Jannich Hansen

Sæby

01/12/2016

Jannich Hansen

(signature)

Jannich Hansen

NOTES:

Date	
Weighing	g
kW low	kW
kW high	kW
Blower low	%
Blower middle	%
Blower high	%
Comments:	

Date	
Weighing	g
kW low	kW
kW high	kW
Blower low	%
Blower middle	%
Blower high	%
Comments:	

Date	
Weighing	g
kW low	kW
kW high	kW
Blower low	%
Blower middle	%
Blower high	%
Comments:	

Date	
Weighing	g
kW low	kW
kW high	kW
Blower low	%
Blower middle	%
Blower high	%
Comments:	

Date	
Weighing	g
kW low	kW
kW high	kW
Blower low	%
Blower middle	%
Blower high	%
Comments:	

Date	
Weighing	g
kW low	kW
kW high	kW
Blower low	%
Blower middle	%
Blower high	%
Comments:	

NOTES:

Date	
Weighing	g
kW low	kW
kW high	kW
Blower low	%
Blower middle	%
Blower high	%
Comments:	

Date	
Weighing	g
kW low	kW
kW high	kW
Blower low	%
Blower middle	%
Blower high	%
Comments:	

Date	
Weighing	g
kW low	kW
kW high	kW
Blower low	%
Blower middle	%
Blower high	%
Comments:	

Date	
Weighing	g
kW low	kW
kW high	kW
Blower low	%
Blower middle	%
Blower high	%
Comments:	

Date	
Weighing	g
kW low	kW
kW high	kW
Blower low	%
Blower middle	%
Blower high	%
Comments:	

Date	
Weighing	g
kW low	kW
kW high	kW
Blower low	%
Blower middle	%
Blower high	%
Comments:	

NBE

PRODUCTION A/S

Kjeldgaardsvej 2

9300 SÆBY

Tlf. 8820 9230

CVR nr. 34 89 03 23



NBE STOKER CLOUD

